

GENERAL

Detection	Equipped for magnetic position detectors
Fluid	Air or neutral gas, filtered, lubricated or not
Operating pressure	1 to 7 bar
Ambient temperature	+ 5°C, +60°C
Rotation	90° - 180° (±5°)
Cushioning	Non cushioned

DEVELOPED MOMENTS

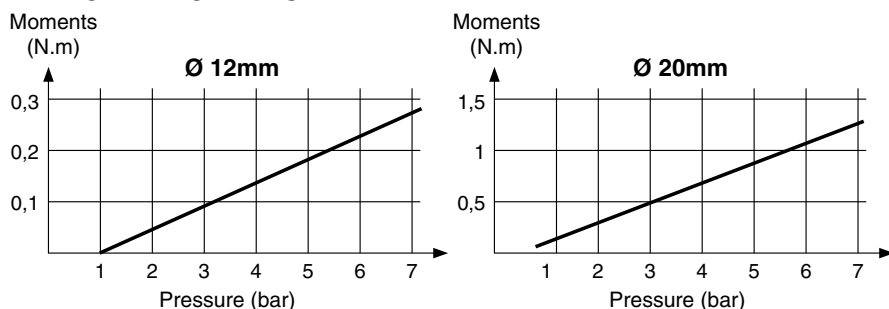

For an optimum installation of a cylinder, we recommend a cylinder with the necessary moment equal to 70% of the developed moment

MAXIMUM ALLOWABLE MOMENTUM

Maximum allowable momentum **Ø12 = 4 x 10-3J**
Ø20 = 1x10-2J

In case of heavy load and high speed rotation, momentum at stroke end may exceed the above limits and damage the rotatable cylinder. To limit momentum, reduce the rotation speed with flow regulators (as close to the cylinder as possible).

CONSTRUCTION

Body	Light alloy
Stop	Steel
Rod	Steel
Seals	NBR (nitrile)

SPECIFICATIONS (SINGLE ROD CYLINDER)

Ø (mm)	rotation	catalogue number	reference	weight (kg)
12	90°	42900042	R12 D 90-M	0,130
	180°	42900043	R12 D 180-M	0,130
20	90°	42900046	R20 D 90-M	0,250
	180°	42900047	R20 D 180-M	0,320

POSITION DETECTORS : consult us



B

DIMENSIONS (mm)



Rotatable 180°

Rotatable 90°

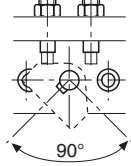
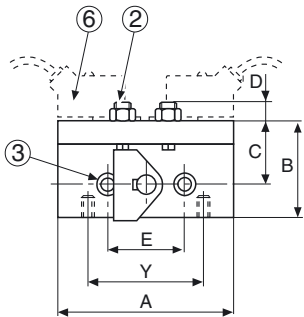
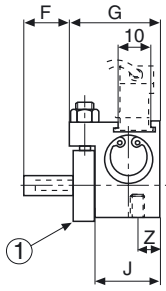

Ø (mm)	A		B	C	D	E	F
	90°	180°					
12	55	55	30	20	6	24	15
20	53	72	42	30	10	35	20

Ø (mm)	G	J	L	N	P	Y	Z
	12	28	20	6	7,2	16,5	34
20	35	25,5	8	9,2	21	43	12

- ① : Stop boss
- ② : Rotation adjusting screw $\pm 5^\circ$
- ③ : Front mounting (see possible mountings below)
- ⑤ : Two Ø M5 supply ports
Port 1 : clockwise, rod side with pin
Port 2 : counterclockwise, rod side with pin
- ⑥ : Reed or MR magnetic position detectors

Installation recommendation:
detectors must be installed with the flying leads or connectors orientated outwards

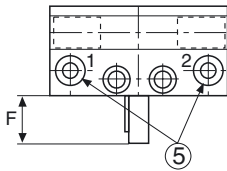
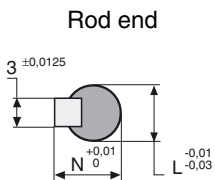

POSSIBILITIES MOUNTINGS

• Bottom mounting

• Front mounting

• Front mounting

• Rear mounting

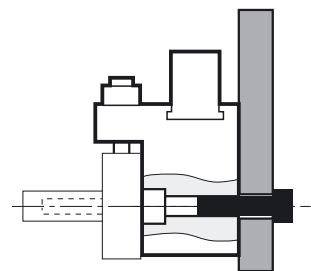
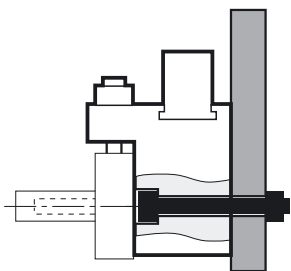
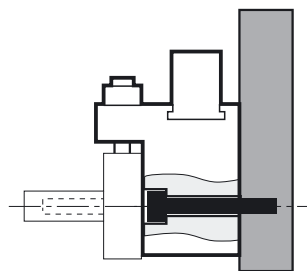
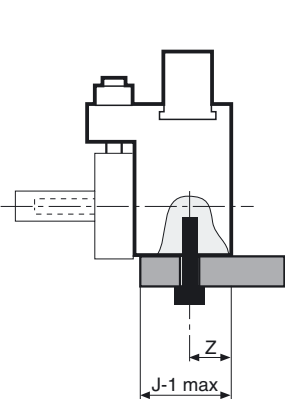

Front mounting
 $\text{Ø } 12$: 2 x $\text{Ø } 3,3$ counterbored $\text{Ø } 6,5$ depth 3,5
 $\text{Ø } 20$: 2 x $\text{Ø } 4,2$ counterbored $\text{Ø } 8$ depth 4,5

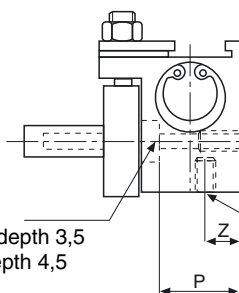

Rear side mounting
 $\text{Ø } 12$: 2 Ø M4 depth 8
 $\text{Ø } 20$: 2 Ø M5 prof. 10

Bottom mounting
 $\text{Ø } 12$: 2 Ø M4 depth 7
 $\text{Ø } 20$: 2 Ø M5 depth 8

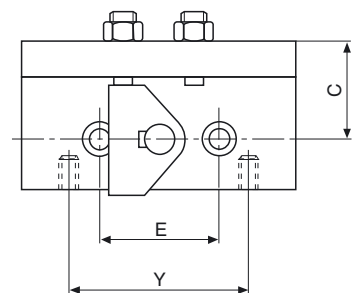

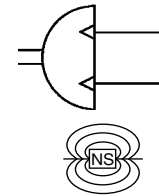

GENERAL

Detection
Fluid
Operating pressure
Ambient temperature
Rotation

Equipped for magnetic position detectors
Air or neutral gas, filtered, lubricated or not
2 to 7 bar
+ 5°C, +60°C

position number	rotation possibilities	total rotation
2	90°	90°
2	180°	180°
3	90° + 90°	180°
4	2α + β	180°

Adjustment of angular movement on extreme 2 positions (see below)

Cushioning

- 2 position models
- 3 and 4 position models

Adjustable pneumatic cushioning
No cushioning



B

ANGULAR MOVEMENT

2 position model

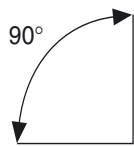

Adjustment range* : 70° — 95°

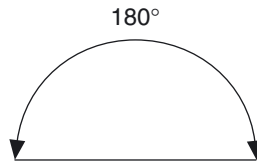

Adjustment range* : 160° — 185°

3 and 4 position model

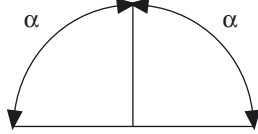

α 90°
Adjustment range* : 120° — 185°

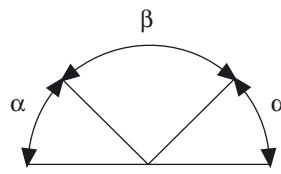

2 α + β
Adjustment range* : 120° — 185°
Any values α and β, 2 α + β having to be equal to 180°.

* Movement limits to be distributed to both ends.

SPECIFICATIONS

position number	rotation angle	Ø (mm)	catalogue number	reference	connection Ø
2	90°	16	42900052	RS16 A2. 90 /M	M5
		18	42900056	RS18 A2. 90 /M	
		22	42900060	RS22 A2. 90 /M	
2	180°	16	42900053	RS16 A2. 180 /M	M5
		18	42900057	RS18 A2. 180 /M	
		22	42900061	RS22 A2. 180 /M	
3	90° + 90°	16	42900054	RS16 NA3. 90+90 /M	M5
		18	42900058	RS18 NA3. 90+90 /M	
		22	42900062	RS22 NA3. 90+90 /M	
4	α + β + α	16	42900055*	RS16 NA4. α + β /M*	M5
		18	42900059*	RS18 NA4. α + β /M*	
		22	42900063*	RS22 NA4. α + β /M*	

* Define angles α + β (2 α + β = 180°).

POSITION DETECTORS : consult us

MOMENTS DEVELOPED

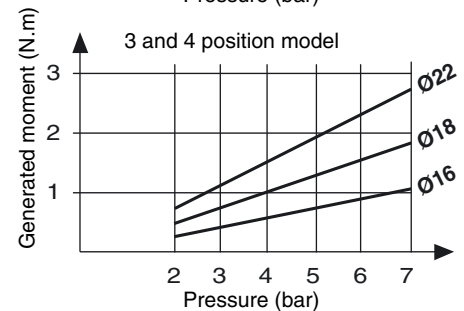
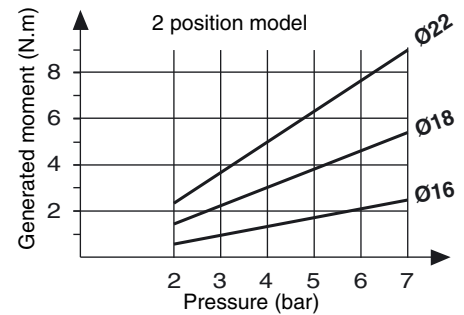

For an optimum use, it is recommended to define a rotatable cylinder whose moment is 70 % of the developed moment.

FUNCTIONING PRINCIPLE

3 position model

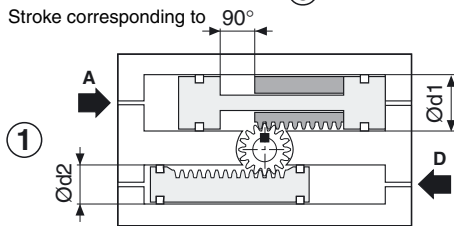
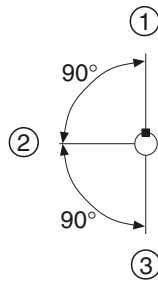

2a

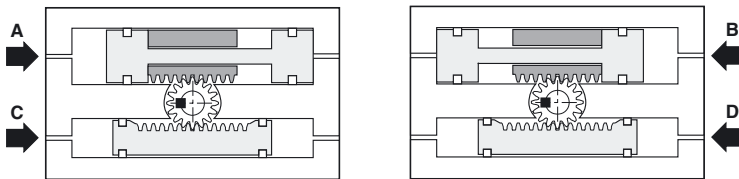

3

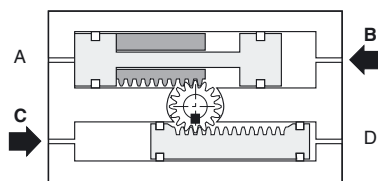

Two choices, to obtain position 2 (2a or 2b). From a given position, the rotatable cylinder may be placed on any other 2 positions.

Pneumatic command table

outlets	positions			
	①	②a	②b	③
A	—	—		
B			—	—
C		—		—
D	—		—	

4 position model

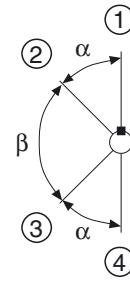

$\varnothing d1 > \varnothing d2$

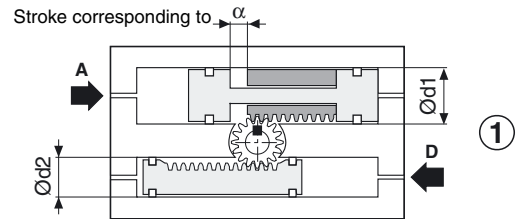

2b

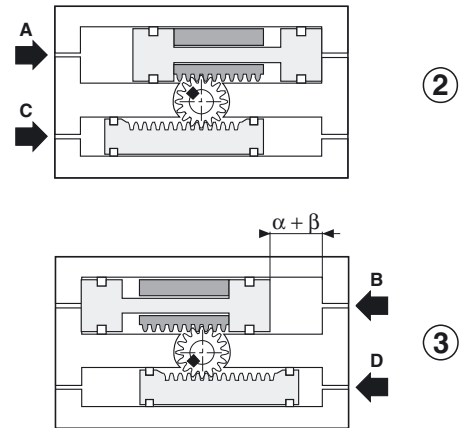

4

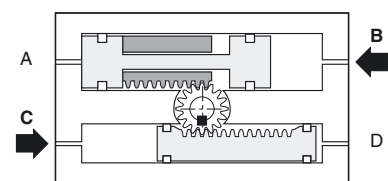

From a given position, the rotatable cylinder may be placed on any other 2 positions.

Pneumatic command table

outlets	positions			
	①	②	③	④
A	—	—		
B			—	—
C		—		—
D	—		—	

model		Ø 16			Ø 18			Ø 22		
position number		2	3-4		2	3-4		2	3-4	
Ø bores (mm)	Ø d1	24			26			30		
	Ø d2	16			18			22		
crossrod Ø	(mm)	Ø 10 ^{h7}			Ø 12 ^{h7}			Ø 15 ^{h7}		
moment developed	N.m	see chart			see chart			see chart		
rotation angle	(°)	90°	180°	180°	90°	180°	180°	90°	180°	180°
adjustable angle	(°)	70—95	160—185	120—185	70—95	160—185	120—185	70—95	160—185	120—185
pneumatic cushioning		yes	yes	no	yes	yes	no	yes	yes	no
cushioning angle	(°)	60	60	—	40	40	—	40	40	—
maximum momentum	J	14x10 ⁻²	14x10 ⁻²	3,5x10 ⁻²	28x10 ⁻²	28x10 ⁻²	7x10 ⁻²	42x10 ⁻²	42x10 ⁻²	11x10 ⁻²

If the momentum generated by the application exceeds the above defined maximum values, rotation speed must be reduced with flow regulators (to be placed at closest to the cylinder) or with shock absorbers.

POSSIBLE MOUNTING OF ROTATABLE CYLINDERS

• **Front mounting**

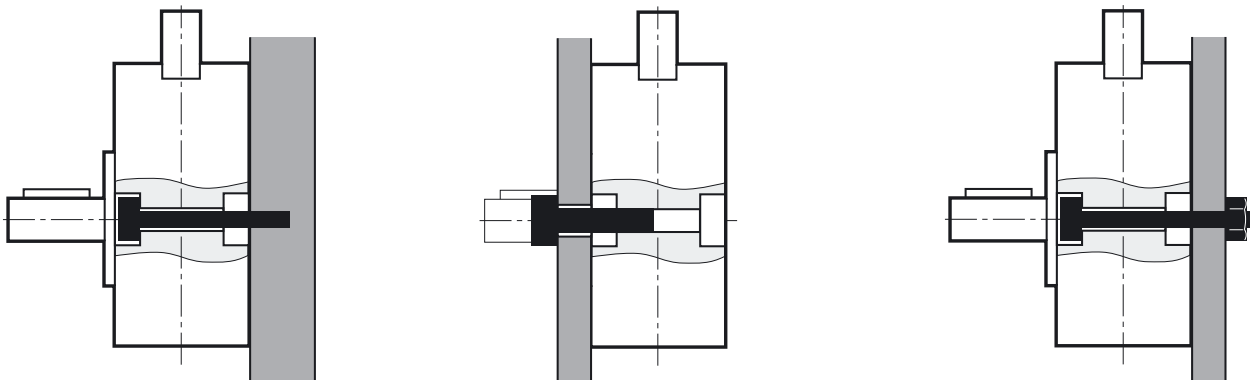

• **Bottom mounting**

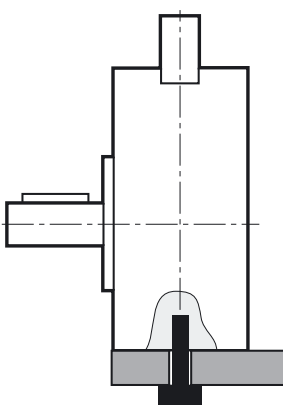

• **Rear mounting**

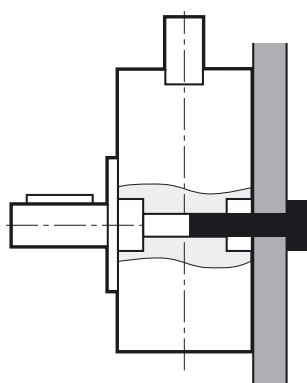

• **Rear mounting**

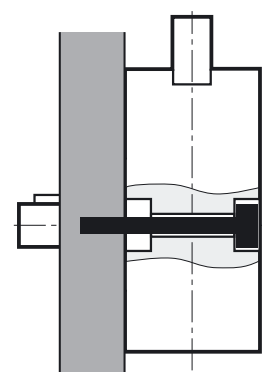

B

DIMENSIONS (mm), WEIGHT (kg)

2 positions

- ① : Front mounting :
2 - Ø S1, counterbore Ø S2,
depth S3
- ② : Rear mounting :
2 - Ø S4
- ③ : Bottom mounting :
4 - Ø P1, depth P2,
- ④ : 2 pneumatic supply
ports Ø M5
- ⑤ : 2 angle movement adjustment screws
- ⑥ : Reed or MR magnetic position detectors

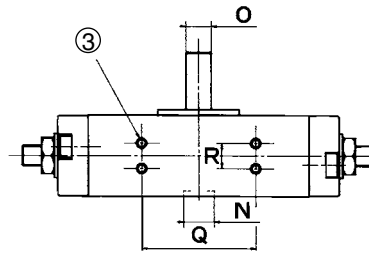
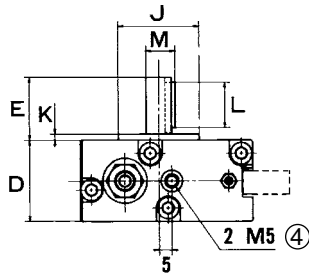

Installation recommendation:
detectors must be installed with the
flying leads or connectors orientated
outwards

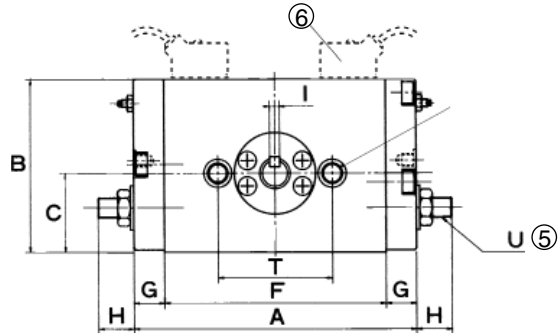

	masse		
	Ø 16	Ø 18	Ø 22
90°	0,7	1,0	1,6
180°	0,8	1,2	1,8

3 or 4 positions

- ① : Front mounting :
2 - Ø S1, counterbore Ø S2,
depth S3
 - ② : Rear mounting :
2 - Ø S4
 - ③ : Bottom mounting :
4 - Ø P1, depth P2,
 - ④ : 4 pneumatic supply
ports Ø M5
 - ⑤ : 2 angle movement adjustment screws
 - ⑥ : Reed or MR magnetic position detectors
- Installation recommendation:**
detectors must be installed with the
flying leads or connectors orientated
outwards

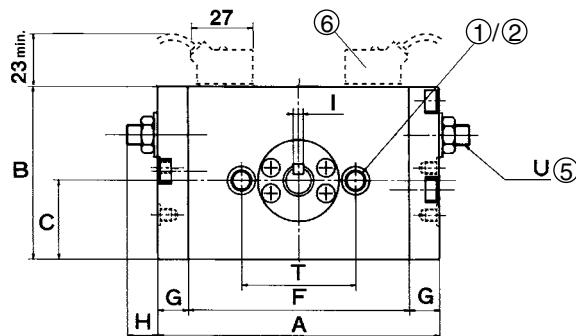
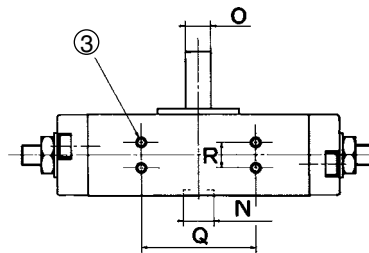
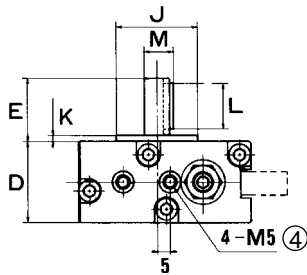

	weight		
	Ø 16	Ø 18	Ø 22
180°	0,8	1,2	1,8

Ø (mm)	A			B	C	D	E	F			G	H			I
	2 positions		3-4 pos.					2 positions		3-4 pos.		2 positions		3-4 pos.	
	90°	180°	180°					90°	180°	180°		90°	180°	180°	
16	98	111	111	68	31	32	25	74	87	87	12	14	14	12	4 ⁰ / _{0.03}
18	103	135	135	75	34,5	34	30	79	111	111	12	13	14	15	4 ⁰ / _{0.03}
22	115	158	158	87,5	41	39	35	87	130	130	14	15	15	15	5 ⁰ / _{0.03}

Ø (mm)	Ø J	K	L	M	Ø N ⁰⁻⁰⁵	Ø O	Ø P1	P2	Q	R	Ø S1	Ø S2	S3	Ø S4	T	U
16	32 ⁰ / _{0.05}	2,5	18	11,5	12 (*2)	10 ^{h7}	M4x0,7	6	45	10	6,5	11	6,5	M8x1,25	45	M8x1,25
18	37 ⁰ / _{0.05}	3	18	13,5	14 (*1,8)	12 ^{h7}	M5x0,8	7	52	12	8,5	14	8,5	M10x1,50	52	M10x1,50
22	44 ⁰ / _{0.05}	3	20	17	17 (*2)	15 ^{h7}	M6x1	8	60	14	8,5	14	8,5	M10x1,50	60	M10x1,50

* : depth

All leaflets are available on: www.asconumatics.eu

CHOICE OF MODEL

Choose a model so that the necessary moment is 70 % of the developed moment.

ROTATION TIME

HOW TO READ DIAGRAMS

Rotation time with respect to moment of inertia

Example : With a $10 \times 10^{-3} \text{ J.s}^2$ moment, rotation time must be greater than :

- 1.17 s for model Ø 16,
- 0.85 s for model Ø 18,
- 0.67 s for model Ø 22.

Maximum momentum

Example : With a momentum of $50 \times 10^{-3} \text{ J.s}^2$ and a rotation time of 1 s/180°, model Ø 18 may be used with end stroke pneumatic cushioning, since the intersection point is below the maximum momentum.

Example : With a momentum of $100 \times 10^{-3} \text{ J.s}^2$ and a rotation time of 0,5 s/180°, no model is satisfactory since the intersection point is above all maximum momentums.

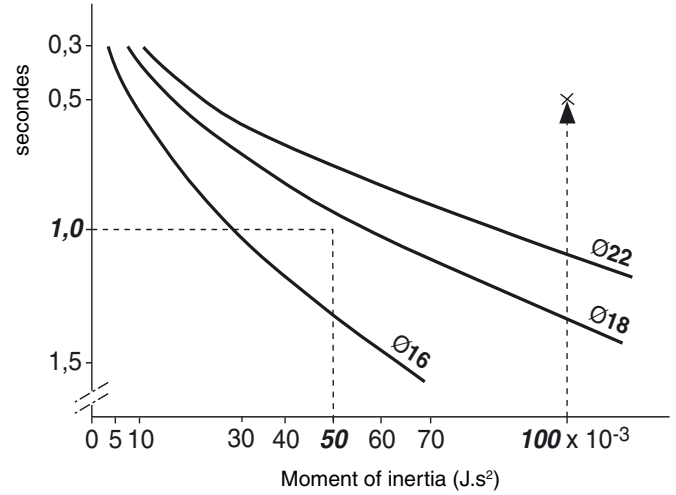
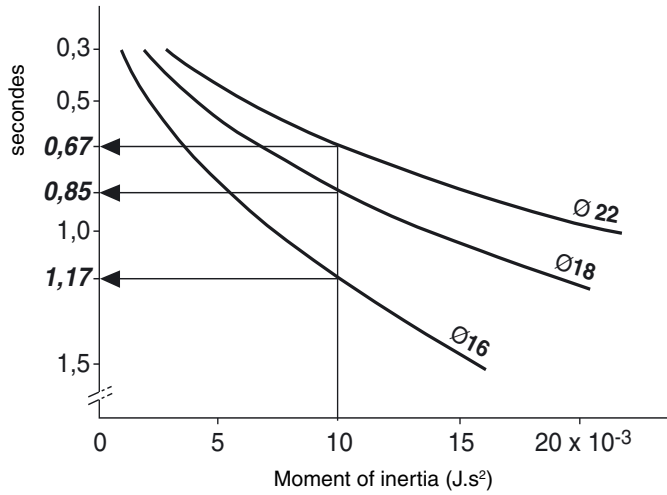

CALCULATION OF MOMENTUM

Momentum is calculated according to the following equation :

$$E = 1/2 I \omega^2$$

- E = momentum, in Joules
- I = moment of inertia, in kg.m²
- ω = axis angular speed of rod at boss stop, in radians / second ($\omega = \theta / t$ rad/s)
- θ = rotation angle in radians ($180^\circ = 3,14$ rad)
- t = rotation time, in seconds

If the actual momentum is greater than the admissible maximum values, rotation speed must be reduced or shock absorbers must be installed.

LOAD ON AXIS

Avoid applying the load directly on the axis, by using a bearing or a stop.

If it cannot be avoided, it must be limited as follows.

type of cylinder	Ø cylinder (mm)	max. radial load (N)	max. axial load (N)
R	12	3	1,5
	20	5	2,5
RS	16	20	10
	18	40	20
	22	60	30

DEFINITION OF MOMENT OF INERTIA

	$I = \frac{m \cdot d^2}{8}$
	$I = \frac{1}{8} (m_1 \cdot d_1^2 + m_2 \cdot d_2^2)$
	$I = \frac{1}{3} (m_1 \cdot Q_1^2 + m_2 \cdot Q_2^2)$
	$I = \frac{m \cdot Q^2}{12}$
	$I = \frac{1}{12} \{m_1 \cdot (4a_1^2 + b^2) + m_2 \cdot (4a_2^2 + b^2)\}$

	$I = \frac{m \cdot a^2}{12}$
	$I = \frac{m \cdot (a^2 + b^2)}{12}$
	$I = \frac{m}{12} \cdot (\frac{d^2}{3} + \frac{Q^2}{4})$
	$I = \frac{m \cdot d^2}{16}$
	$I = \{m_1 \cdot (Q^2 + \frac{d^2}{2}) + \frac{m_2 \cdot Q^2}{3}\}$

00240GB-2006/R01 Availability, design and specifications are subject to change without notice. All rights reserved.

