

Your success counts

Multi Purpose Monitor

with alarm outputs and configurable hysteresis



Application examples: Extreme cold weather regions



Hot and sandy deserts



Red flashing LED backlight in case of an alarm.

The F-Series is your first and safest choice for field mount indicators in safe and hazardous area applications. Especially in harsh weather conditions like rain, snow, salty atmospheres and temperatures between -40°C up to +80°C (-40°F up to 176°F).

Advantages

- Robust aluminum or stainless steel 316L field enclosure (IP67 / NEMA Type4X). It is so rugged, a truck can even stand on it!
- Intrinsically Safe available - ATEX and IECEx approval for gas and dust applications.
- Programming can be done by your own crew, with the sensible menu-driven structure, saving cost and irritation. Know one, know them all!
- Very diverse mounting possibilities: walls, pipes, panels or directly onto outdoor sensors!

Features

- Displays actual value, % and measuring unit.
- 4 alarm values: low-low, low, high and high-high alarms.
- 4 configurable hysteresis modes for alarm set- & resetpoints.
- Large 17mm (0.67") digits.
- Red flashing LED backlight in case of an alarm.
- Wide range of engineering units for e.g. level, temperature, pressure and other applications.
- Create a custom measuring unit with max. 8 characters.
- Signal input: (0)4 - 20mA.
- Analog output according the actual value measured.
- Up to 4 free configurable fail-safe alarm outputs.
- Full Modbus communication RS232/485/TTL.
- Power requirements: Loop or battery powered, 8 - 30V DC, 8 - 24V AC/DC or 115 - 230V AC.
- Sensor supply 3 / 8.2 / 12 / 24V DC.
- Auto backup of all settings.

Introduction

The F190 is a versatile multi purpose indicator with continuous monitoring feature. Beside the focus on level, temperature and pressure applications, it also contains a range of other measuring units and even the possibility to create a custom unit with max. 8 characters. It offers the facility to set two low alarm and two high alarm values with 4 configurable hysteresis modes. If desired, an ignore function can be set up to allow for an incorrect measurement for a certain period of time. A wide selection of options further enhances the capabilities of this model, including Intrinsic Safety and full Modbus communication.

Display

The display has large 17mm (0.67") and 8mm (0.31") digits which can be set to the actual value, measuring unit, % and alarm values. Various alarm messages can be set to each alarm value. The alarm values can be password protected. On-screen engineering units are easily configured from a comprehensive menu. In case of an alarm, the backlight can be set to be red or flashing red. The intensity can be adjusted from the keyboard.

Configuration

All configuration settings are accessed via a simple operator menu which can be password protected. Each setting is clearly indicated with an alphanumeric description, to avoid confusing abbreviations. All settings are safely stored in EEPROM memory when a power failure occurs.

Communication

All process data and settings can be read and modified manually or through the Modbus communication link (RS232 / RS485). Full Modbus functionality remains available for the Intrinsically Safe version (TTL).

Hazardous areas

This model is ATEX and IECEx certified as Intrinsically Safe for gas applications with an allowed ambient temperature of -40°C to +70°C (-40°F to +158°F) and dust applications with an allowed ambient temperature of -40°C to +50°C (-40°F to +122°F). A flame proof Ex d enclosure with ATEX/IECEx certification is also available..



Analog output signal

The actual value is re-transmitted with the (0)4 - 20mA output signal. The output signal is updated eight times per second with a filter function being available to smoothen out the signal if desired. The output value is user defined in relation to the level, e.g. 4mA equals to 5m3 and 20mA equals to 20.000 m3. The output signal can be passive, active or isolated where the passive output type will loop power the F190 as well.

Power requirements

Several power supply options are available to power the F190 and sensor. A battery powered version with a long life lithium battery which will last up to five years. A 4-20mA input loop powered version is available as well but cannot power the backlight. A real sensor supply is offered with the 24V AC/DC or 115-230V AC power requirement options.



All info at a glance



Easy to install



Easy to program



Know one know them all!



Reliable



User-friendly

Overview application F190

The F-Series is your first and safest choice for field mount indicators in safe and hazardous area applications. Especially in harsh weather conditions like rain, snow, sandy deserts, salty atmospheres and temperatures between -40°C up to +80°C (-40°F up to 176°F). For monitoring a wide range of process parameters like flow (linear or square root), level, pressure and temperature measurements, even with signal re-transmission or serial communication available.

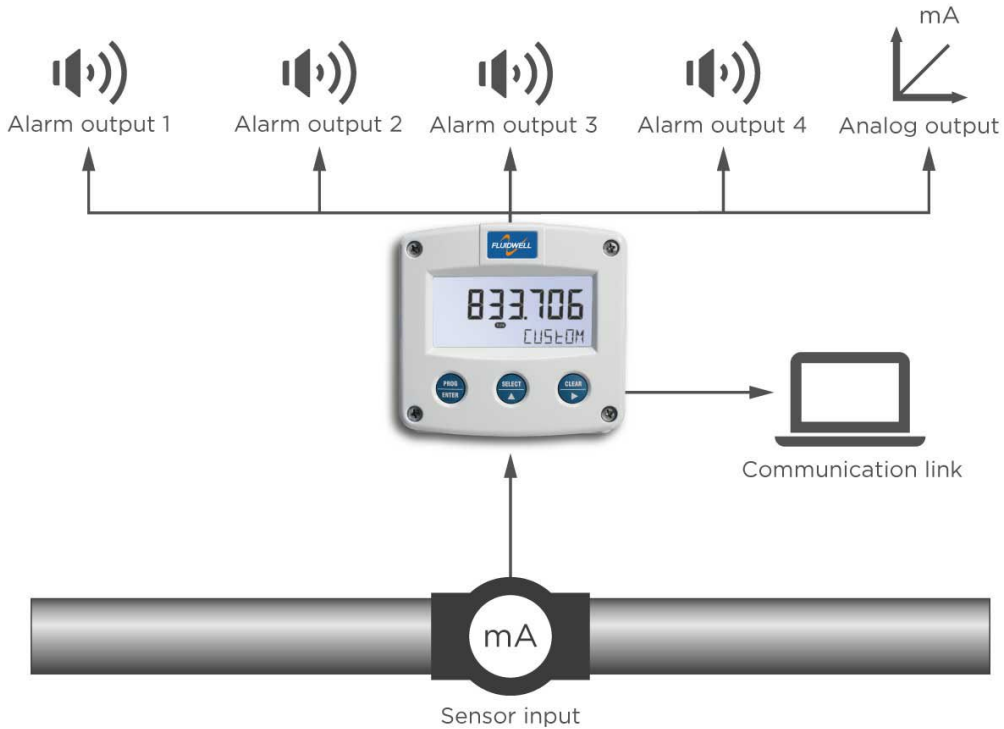

Alarm outputs

Up to four configurable fail-safe outputs with clear alarm function are available to transmit the alarm condition. You can have e.g. two the same low alarm outputs, one high alarm output and one "all alarms" output. Type OS offers four mechanical relay outputs. However, only two outputs are available in Intrinsically Safe applications. Three outputs are available in all other configurations. The output signals can be a passive NPN, active PNP or an isolated electro-mechanical relay.

Hysteresis modes

- Default (disabled): Alarm value = (re-)setpoint.
- Balanced: Alarm value \pm 0.5 hysteresis value = (re-)setpoint.
- Unbalanced: Alarm value = setpoint.
Alarm value \pm hysteresis value = resetpoint.
- Absolute: Alarm value = setpoint.
Programmable resetpoint = resetpoint.

Signal input

The F190 accepts (0)4 - 20mA input signals from any type of analog measurement device. Also a 4 - 20mA input loop powered model is available.



Robust, even a truck can stand on it!



Resistant to harsh weather

Enclosures

Various types of enclosures can be selected, all ATEX and IECEx approved. The F190 is supplied in an GRP panel mount enclosure as standard, which can be converted to an IP67 / NEMA Type4X GRP field mount enclosure by the addition of a back case. Most popular is our robust aluminum field mount enclosure which is also available with an extended backcover with undrilled preparation for direct meter mounting at the back side. It is so rugged, even a truck can stand on it! For the most challenging environments we have a durable high grade Stainless steel 316L enclosure. All enclosures have a IP67 / NEMA Type4X rating and EU or U.S. cable gland entry threads available.

Dimensions enclosures

Aluminum & GRP panel mount enclosure

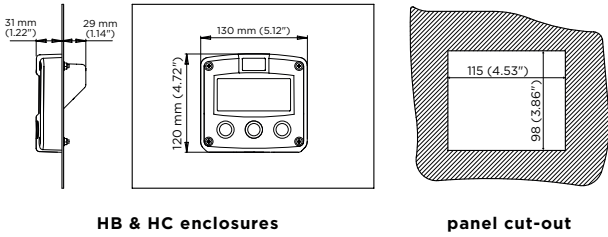

HB & HC enclosures

panel cut-out

Cable entries

Aluminum / Stainless Steel

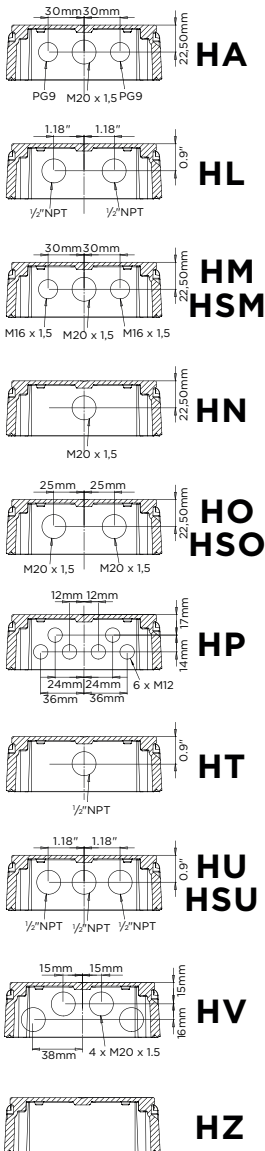

GRP

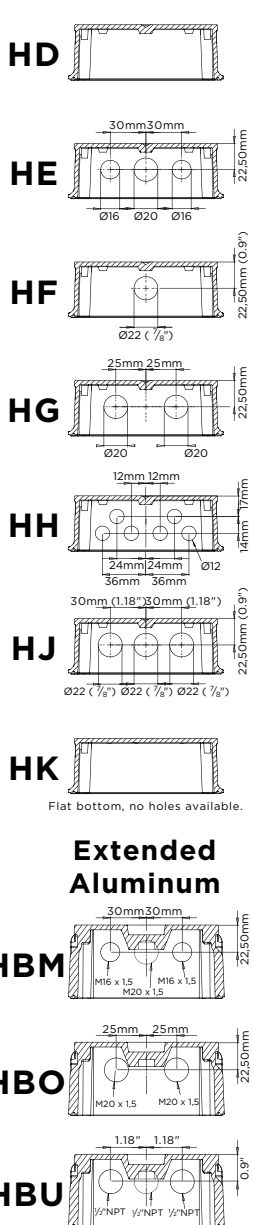

Extended Aluminum

Aluminum, GRP & Stainless steel 316L field mount enclosures

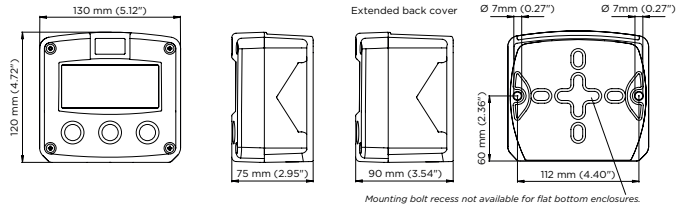

Terminal connections

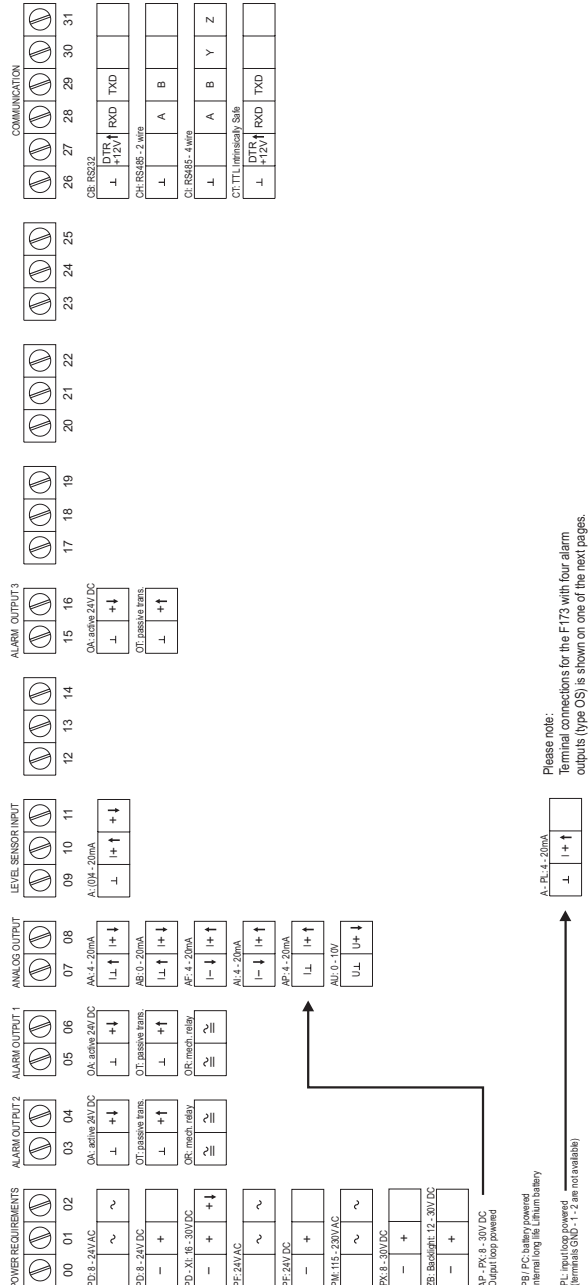

Please note:
Terminal connections for the F173 with four alarm outputs (type OS) is shown on one of the next pages.

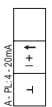

FL input powered / Internal long life Li-Iron battery (standard OS - 1-2 are not available)
PB / PC battery powered
Output loop powered

Configuration example F190-A-AP-CH-OT-PX-XX-ZX

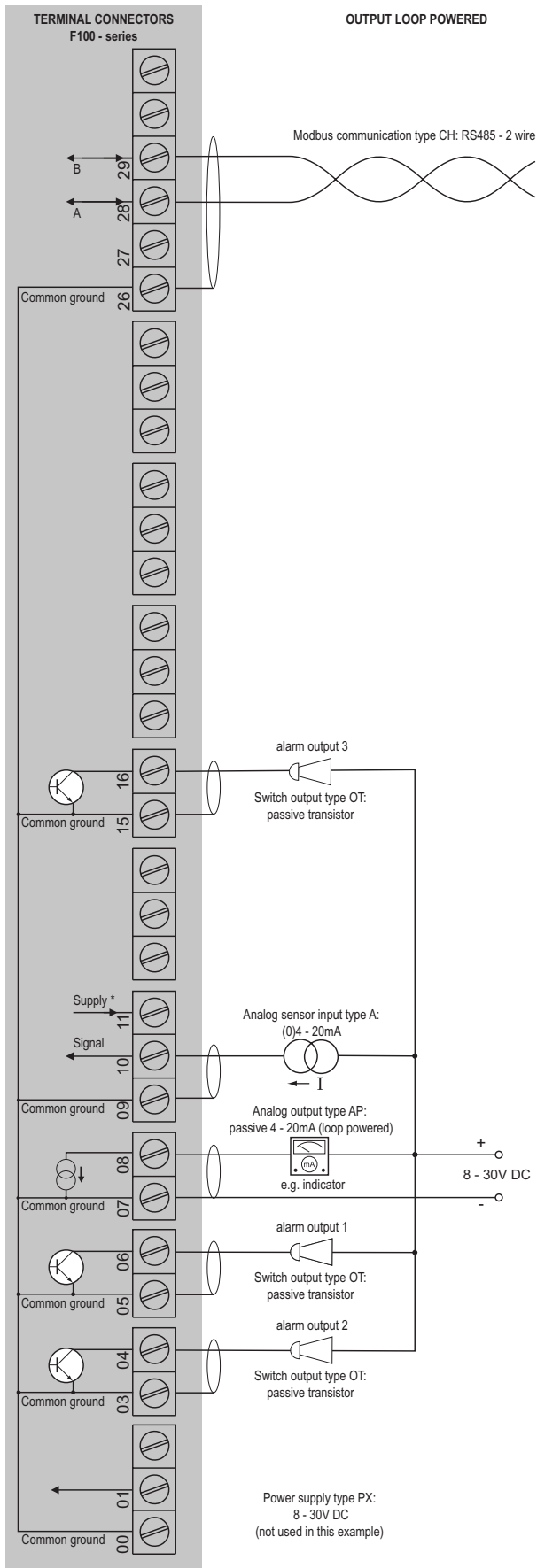

*Supply voltage: 3.2V DC to sensor

Configuration example F190-P-AP-CB-OS-PD-XX-ZX

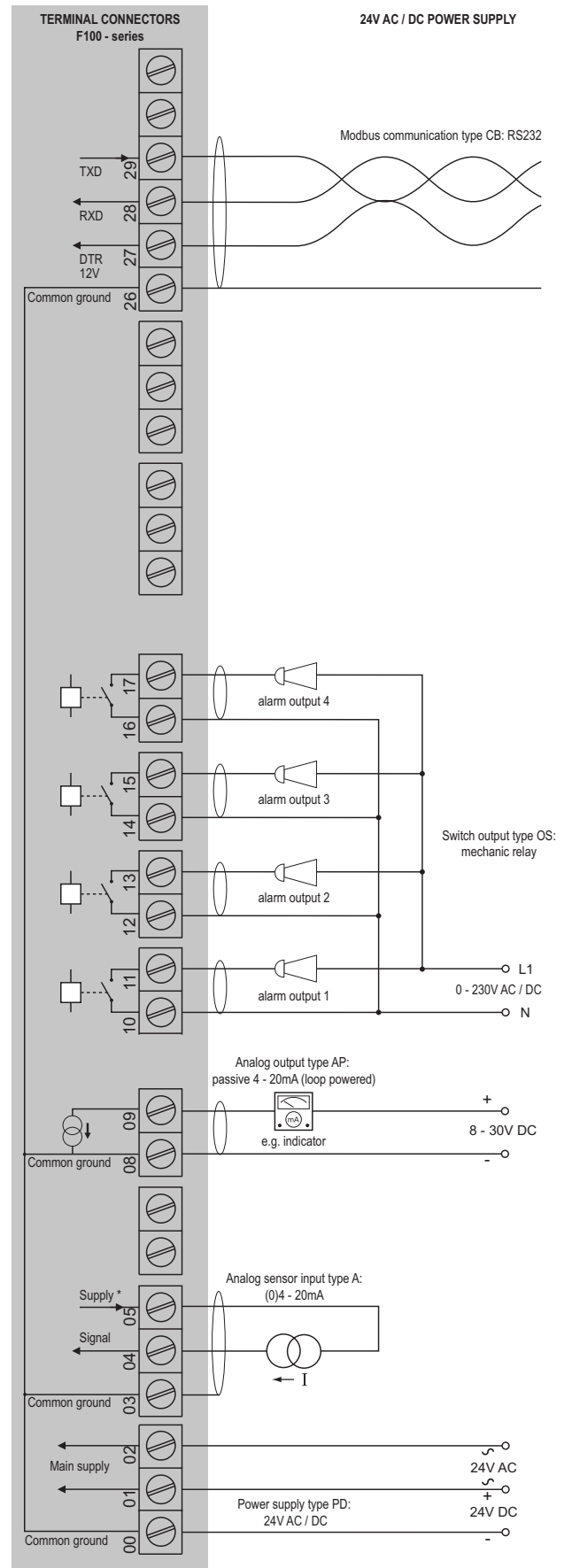

* U_{max} sensor is 2V below U_{supply}
 U_{max} sensor: 8.2V requires 10VDC(8VAC) U_{supply}
 12V requires 14VDC(10VAC) U_{supply}
 24V requires 26VDC(18VAC) U_{supply}

Hazardous area applications

The F190-XI has been certified according to ATEX and IECEx by DEKRA for use in Intrinsically Safe applications with an ambient temperature of -40°C to +70°C (-40°F to +158°F). For equipment category Dust, zone 20 (1 D / EPL Da), the maximum ambient temperature is limited to 50°C (+122°F) and a maximum dust layer thickness of 200mm.

- The ATEX markings for gas and dust applications are:
 - Gas: **II 1 G Ex ia IIB/IIC T4 Ga.**
 - Dust: **II 1 D Ex ia IIIC T₂₀₀ 100 °C Da.**
- The IECEx markings for gas and dust applications are:
 - Gas: **Ex ia IIC/IIB T4 Ga.**
 - Dust: **Ex ia IIIC T₂₀₀ 100 °C Da.**

Besides the I.S. power supplies for the two alarm outputs, it is allowed to connect up to three I.S. power supplies in IIB/IIC applications or one in IIC applications. Consult the certificate for the maximum input and output values of the circuits. Full functionality of the F190 remains available, including two alarm outputs and 4 - 20mA output and Modbus communication (type CT). Power supply type PD-XI offers a sensor supply according to the connected power supply voltage at terminal 1. An ATEX/IECEx approved flame proof Ex d enclosure is available as well. Please contact your supplier for further details.

Certificate of conformity KEMA 03ATEX1074 X

• IECEx DEK 11.0042X



Configuration example IIB / IIC - F190-A-CT-OT-PC-XI - Battery powered

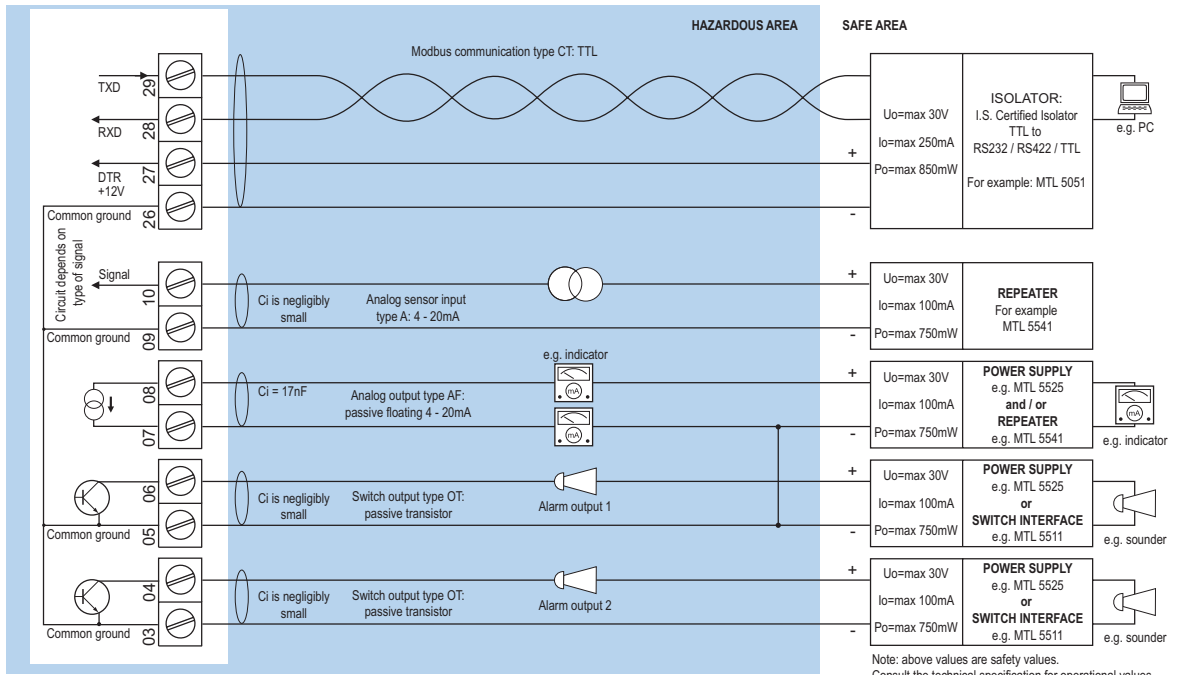

Note: above values are safety values. Consult the technical specification for operational values.

Configuration example IIB / IIIC - F190-A-AP-CT-OT-(PX)-XI - Output loop powered

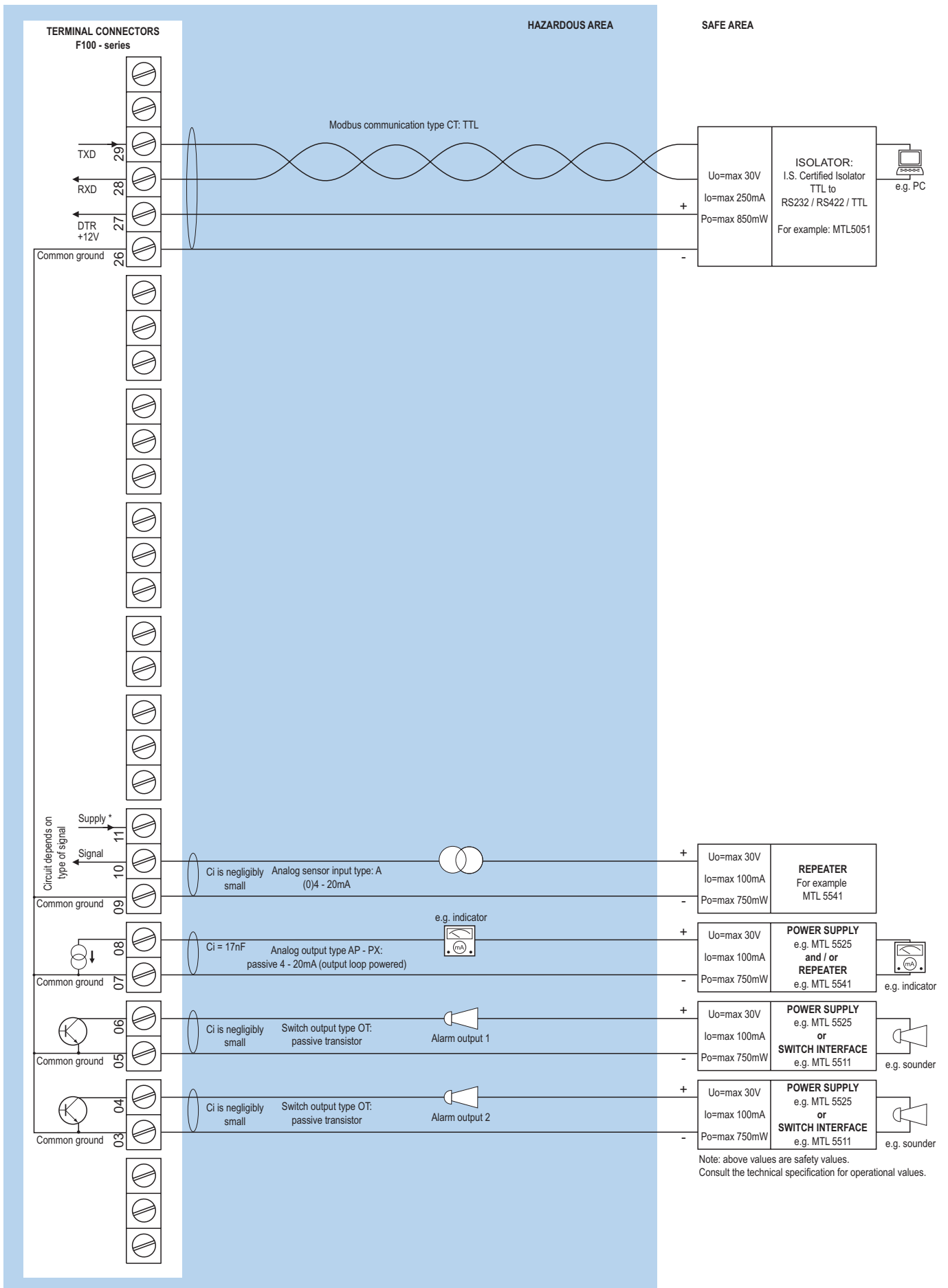

Configuration example IIB / IIIC and IIC - F190-A-AP-(CT)-OT-PD-XI - Power requirement 16 - 30V DC

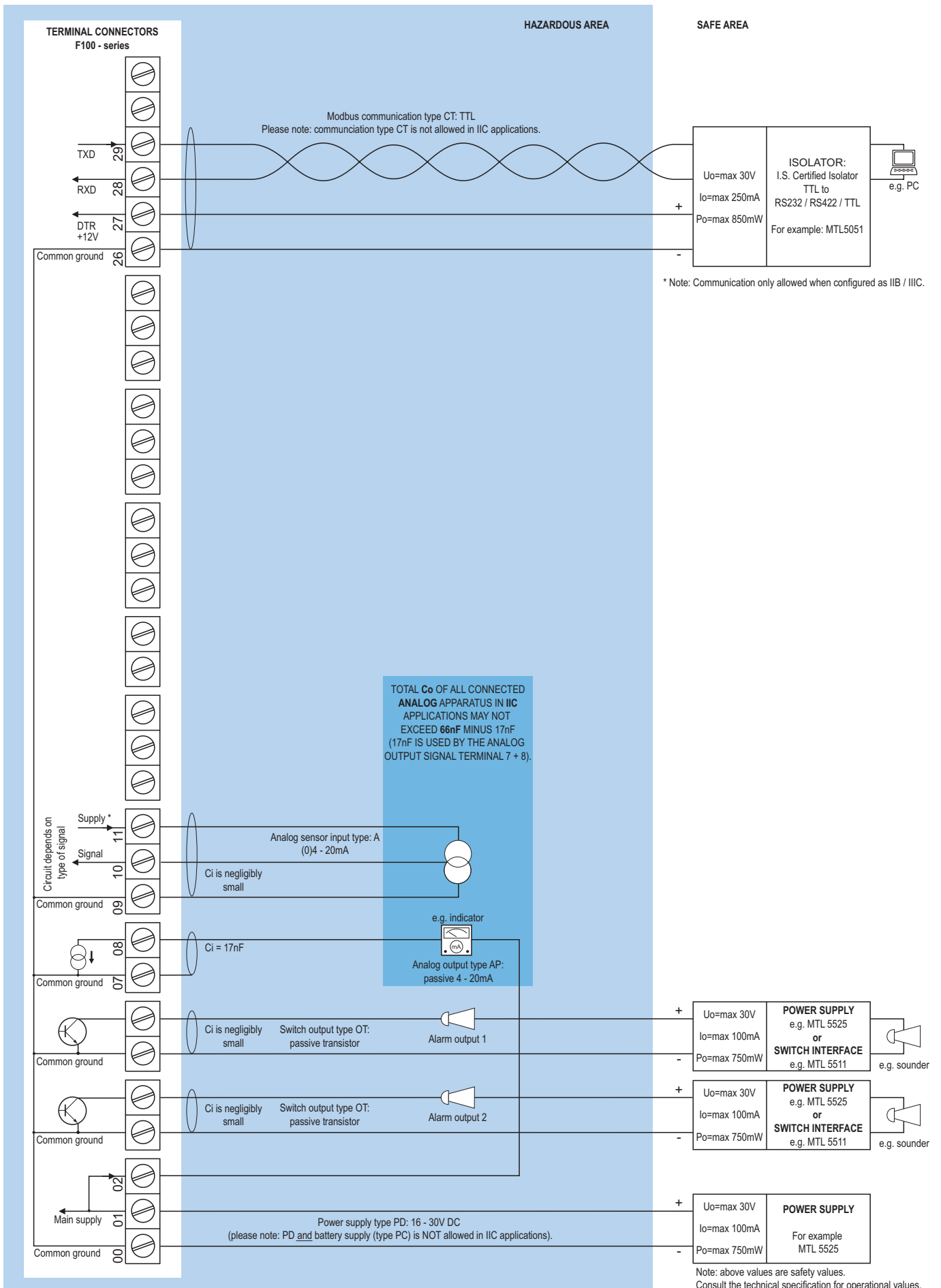

* Note power supply type PD: the supply voltage to the analog sensor is as connected to terminal 1 (internally linked).

Configuration example IIB / IIIC - F190-A-AF-CT-OT-(PC)-(PD)-XI - Power requirement 16 - 30V DC or battery powered

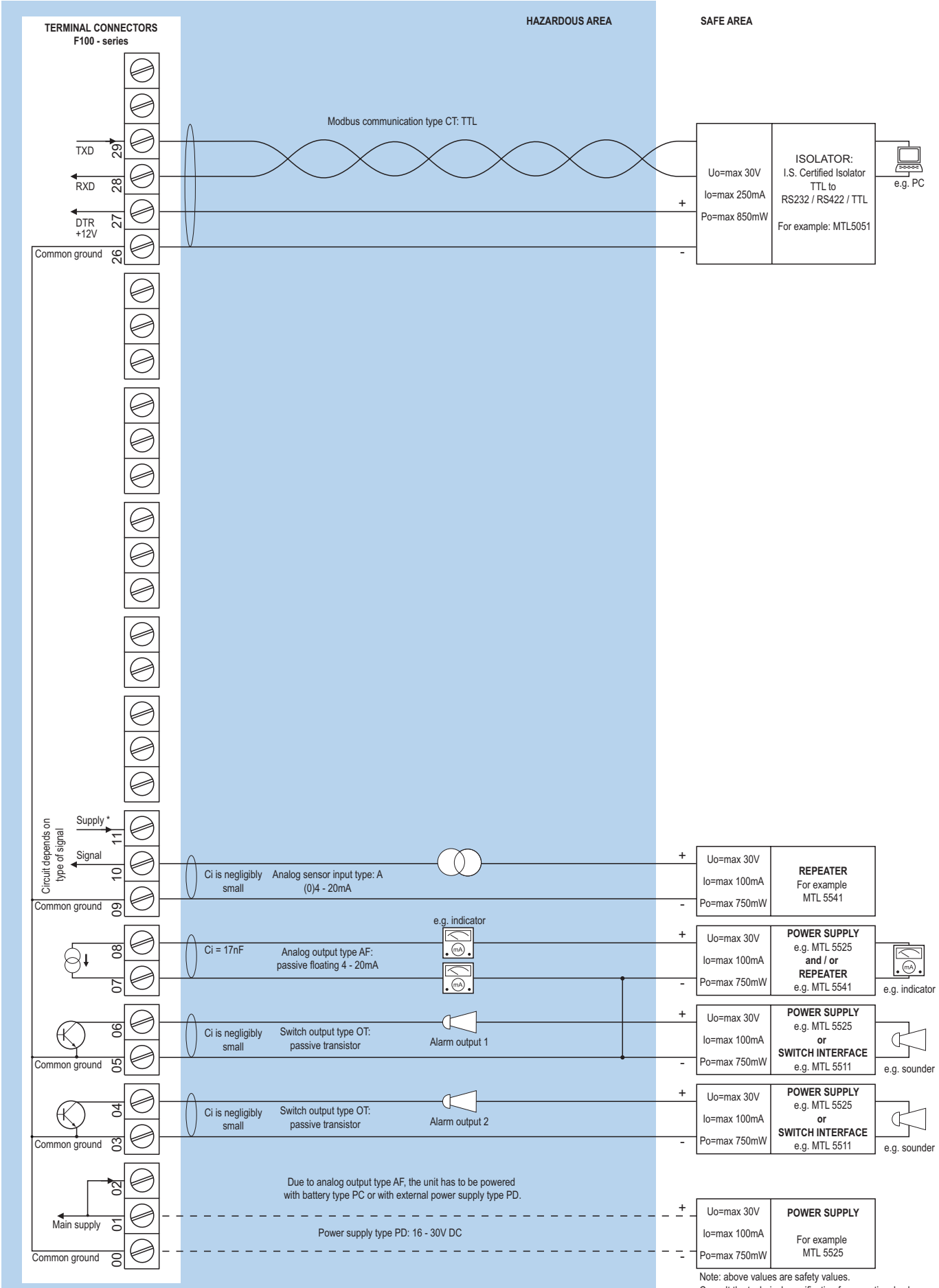

* Note power supply type PD: the supply voltage to the analog sensor is as connected to terminal 1 (internally linked).

Display

Type	High intensity reflective numeric and alphanumeric LCD, UV-resistant.
Dimensions	90 x 40mm (3.5" x 1.6").
Digits	Seven 17mm (0.67") and eleven 8mm (0.31") digits. Various symbols and measuring units.
Refresh rate	User definable: fast, 1sec, 3sec, 15sec, 30sec, off.
Option ZB	Transflective LCD with white LED-backlight. Red (flashing) backlight during alarm conditions. Intensity and alarm response selected through the keyboard. Good readings in full sunlight / darkness.
Note ZB	Only available for safe area applications. with option PD, PF, PM or PX.

Ambient temperature

Safe areas	-40°C to +80°C (-40°F to +176°F).
Intrinsically Safe	-40°C to +70°C (-40°F to +158°F).
Dust, zone 20	-40°C to +50°C (-40°F to +122°F).

Terminal connections

Type	Removable plug-in terminal strip. Wire max. 1.5mm ² and 2.5mm ² .
-------------	---

Data protection

Type	EEPROM backup of all settings. Backup of running totals every minute. Data retention at least 10 years.
Password	Configuration settings can be password protected.

Directives & Standards

EMC	Directive 2014/30/EU, FCC 47 CFR part 15.
Low voltage	Directive 2014/35/EU
RoHS	Directive 2011/65/EU
ATEX / IECEx	Directive 2014/34/EU, IEC 600079-0, IEC 60079-11.
IP & NEMA	EN 60529 & NEMA 250

Intrinsically Safe (Type XI)

ATEX	Gas: II 1 G Ex ia IIB/IIC T4 Ga. Dust: II 1 D Ex ia IIIC T ₂₀₀ 100 °C Da.
IECEX	Gas: Ex ia IIC/IIB T4 Ga. Dust: Ex ia IIIC T ₂₀₀ 100 °C Da.
Ambient Ta	-40°C to +70°C (-40°F to +158°F).
Dust, zone 20	-40°C to +50°C (-40°F to +122°F).

Explosion proof (Type XF)

ATEX/IECEX	Gas: II 2 G Ex db IIB+H2 T5 Gb. Dust: II 2 D Ex tb IIIC T80°C.
Protection	IP66
Type XF	Dimensions of enclosure: 300 x 250 x 200mm (11.8" x 9.9" x 7.9") L x H x D.
Weight	Appr. 15kg.

Enclosure

Window	Polycarbonate window.
Sealing	Silicone.
Control keys	Three industrial micro-switch keys. UV-resistant silicone keypad.

Panel mount enclosures

Dimensions	130 x 120 x 60mm (5.12" x 4.72" x 2.36") - W x H x D.
Panel cut-out	115 x 98mm (4.53" x 3.86") L x H.
Type HB	Die-cast aluminum panel mount enclosure IP65 / NEMA Type4X.
Weight	600 gr.
Type HC	GRP panel mount enclosure IP65 / NEMA Type4X, UV-resistant and flame retardant.
Weight	450 gr.
Type HSB	Die-cast stainless steel 316L IP67 / NEMA Type4X.
Weight	1150gr.

GRP wall / field mount enclosures

General	GRP wall/field mount enclosure IP67 / NEMA Type4X, UV-resistant and flame retardant.
Dimensions	130 x 120 x 75mm (5.12" x 4.72" x 2.95") - W x H x D.
Weight	600 gr.
Type HD	Cable entry: no holes.
Type HE	Cable entry: 2 x Ø 16mm and 1 x Ø 20mm.
Type HF	Cable entry: 1 x Ø 22mm (7/8").
Type HG	Cable entry: 2 x Ø 20mm.
Type HH	Cable entry: 6 x Ø 12mm.
Type HJ	Cable entry: 3 x Ø 22mm (7/8").
Type HK	Flat bottom, cable entry: no holes.

Aluminum wall / field mount enclosures

General	Die-cast aluminum wall/field mount enclosure IP67 / NEMA Type4X with 2-component UV-resistant coating. Extended back cover available with undrilled preparation for direct meter mounting.
Dimensions	130 x 120 x 75mm (5.12" x 4.72" x 2.95") - W x H x D. 130 x 120 x 90mm (5.12" x 4.72" x 3.54") - W x H x D.
Weight	1100 gr. / extended enclosure: 1310 gr.
Type HA	Cable entry: 2 x PG9 and 1 x M20.
Type HL	Cable entry: 2 x 1/2" NPT.
Type HM/HBM	Cable entry: 2 x M16 and 1 x M20.
Type HN	Cable entry: 1 x M20.
Type HO/HBO	Cable entry: 2 x M20.
Type HP	Cable entry: 6 x M12.
Type HT	Cable entry: 1 x 1/2" NPT.
Type HU/HBU	Cable entry: 3 x 1/2" NPT.
Type HV	Cable entry: 4 x M20.
Type HZ	Cable entry: no holes.

Stainless steel 316L wall / field mount enclosures

General	Die-cast stainless steel 316L wall / field mount enclosure with flat bottom. IP67 / NEMA Type4X.
Dimensions	130 x 120 x 75mm (5.12" x 4.72" x 2.95") - W x H x D.
Weight	2700 gr.
Type HSM	Cable entry: 2 x M16 + 1 x M20.
Type HSO	Cable entry: 2 x M20.
Type HSU	Cable entry: 3 x 1/2" NPT.

Signal inputs - Analog sensor

Type A	(0)4 - 20mA. Analog input signal can be scaled to any desired range within 0 - 20mA.
Type U	0 - 10V DC. Contact factory.
Accuracy	Resolution: 14 bit. Error < 0.025mA / ± 0.125% FS. Low level cut-off programmable.
Span	0.000010 - 9,999,999 with variable decimal position.
Update time	Four times per second.
Voltage drop	Type A: 2.5V @ 20mA.
Relationship	Linear calculation.
Note A	For signal type A: external power to sensor is required; e.g. type PD.

Signal outputs - Digital output

Alarm outputs	User defined: low, low-low, high, high-high or all alarms output with optional clear alarm output function, e.g. to turn off an acoustic alarm. Each output can be activated in setup mode to test the wiring and performance of the outputs.
Output behaviour	User defined: Default (closed output during alarm condition), fail-safe (inverted), pulsating (0.25Hz - 2sec. on / 2sec. off).
Type OA	Three active 24V DC transistor outputs (PNP); max. 50mA per output (requires -PD, PF, PM or PX). Requires min. 24V power supply
Type OR	Two electro-mechanical relay outputs isolated max. switch power 230V AC (N.O.) - 0.5A per relay and one OT passive transistor output (requires PF or PM).
Type OS	Four electro-mechanical relay outputs - isolated; max. switch power 230V AC - 0.5A per relay (requires AP and PD with 24V AC / DC).
Type OT	Three passive transistor outputs (NPN) - not isolated. Max. 50V DC - 300mA per output.
Note XI	Intrinsically Safe applications: only two transistor outputs type OT available.

Signal outputs - Analog output

Function	Transmitting actual measured value.
Accuracy	10 bit. Error < 0.05%. Analog output signal can be scaled to any desired range.
Update time	Eight times per second.
Type AA	Active 4 - 20mA output (requires PD, PF, PM or PX).
Type AB	Active 0 - 20mA output (requires PD, PF, PM or PX).
Type AF	Passive floating 4 - 20mA output for Intrinsically Safe applications (requires XI + PD).
Type AI	Passive galvanically isolated 4 - 20mA output - also available for battery powered models.
Type AP	Passive 4 - 20mA output - not isolated. Unit will be loop powered.
Type AU	Active 0 - 10V DC output (requires PD, PF, PM or PX). Requires min. 12V power supply.

Signal outputs - Communication option

Function	Reading display information and reading / writing all configuration settings.
Protocol	Modbus ASCII / RTU.
Speed	1200 - 2400 - 4800 - 9600 baud.
Addressing	Maximum 255 addresses.
Type CB	RS232
Type CH	RS485 2-wire
Type CI	RS485 4-wire
Type CT	TTL Intrinsically Safe.

Mounting accessories

ACF02	Stainless steel wall mounting kit.
ACF05	Stainless steel pipe mounting kit (worm gear clamps not included).
ACF06	Two stainless steel worm gear clamps Ø 44 - 56mm.
ACF07	Two stainless steel worm gear clamps Ø 58 - 75mm.
ACF08	Two stainless steel worm gear clamps Ø 77 - 95mm.
ACF09	Two stainless steel worm gear clamps Ø 106 - 138mm.
ACF11	Swivel with 25° movement from center axis for direct flowmeter mounting: 1" NPT to 1/2" NPT.

Cable glands

ACF20	For HA enclosure, includes O-rings.
ACF25	For HE enclosure, includes locknuts and O-rings.
ACF26	For HF enclosure, includes locknuts and O-rings.
ACF27	For HG enclosure, includes locknuts and O-rings.
ACF28	For HH enclosure, includes locknuts and O-rings.
ACF29	For HJ enclosure, includes locknuts and O-rings.
ACF32	For HM enclosure, includes O-rings.
ACF33	For HN enclosure, includes O-rings.
ACF34	For HO enclosure, includes O-rings.
ACF35	For HP enclosure, includes O-rings.
ACF39	For HT enclosure, includes O-rings.
ACF40	For HU enclosure, includes O-rings.

Intrinsically Safe isolators

ACG01	MTL5511 - One channel pulse or switch output transfer from hazardous area to safe area.
ACG02	MTL5525 - One channel power supply from safe area to hazardous area (e.g. to power the unit with PD or to power a switching or analog device in hazardous area).
ACG03	MTL5541 - One channel 4 - 20mA repeater from hazardous area to safe area.
ACG04	MTL 5051 - Bi-direction serial-data-isolator (for Modbus communication).
ACG05	MTL5516C - Two channel pulse or switch output transfer from hazardous area to safe area.
ACG06	MTL5513 - One channel pulse or switch output transfer from hazardous area to safe area.
ACG07	MTL5546Y - One channel isolated driver bringing 4 - 20mA from safe area to hazardous area, HART transparent, OCD.

Power requirements

Type AP	Analog output loop powered, 8 - 30V DC. Power consumption max 0.5 Watt.
Type PB	Long life Lithium battery - life-time depends upon settings and configuration - up to 5 years. (requires PD, PL or PX)
Type PC	Intrinsically Safe long life lithium battery life-time depends upon settings and configuration - up to 5 years. (requires XI and PD or PX)
Type PD	8 - 24V AC / DC \pm 10%. Power consumption max. 5W.
Type PD-XI	16 - 30V DC power consumption max. 1W.
Type PD-OS	20 - 30V DC / 15 - 24V AC power consumption max. 1W.
Type PF	24V AC / DC \pm 10%. Power consumption max. 15W.
Type PL	Input loop powered from sensor signal 4 - 20mA (type "A") - requires types AI and OT (not Xi). Not available with option ZB.
Type PM	115 - 230V AC \pm 10%. Power consumption max. 15W.
Type PX	8 - 30V DC. Power consumption max. 0.75W.
Type ZB	12 - 30V DC \pm 10%. Power consumption max. 1.5W.
Note PB/PF/PM	Not available Intrinsically Safe.
Note PF/PM	The total consumption of the sensors and outputs may not exceed 400mA @ 24V.
Note XI	For Intrinsically Safe applications, consult the safety values in the certificate.

Sensor excitation

Type PB/PC/PX	3V DC.
Note PB/PC/PX	This is not a real sensor supply. Only suitable for sensors with a very low power consumption.
Type PD	3 / 8.2 / 12 / 24V DC - max. 50mA @ 24V DC. U_{max} sensor is 2V below U_{supply}
Type PD-XI	The sensor supply voltage is according to power supply as connected to terminal 1 (internally linked).
Type PF / PM	3 / 8.2 / 12 / 24V DC - max. 400mA @ 24V DC.

Operator functions

Displayed info	<ul style="list-style-type: none"> Actual value and measuring unit. Percentage. Low-low alarm value. Low alarm value. High alarm value. High-high alarm value. Configurable alarm indication. Alarm values can be set (or only displayed).
-----------------------	--

Actual measured value

Digits	7 digits.
Units	L - nL - mL - M ³ - AM ³ - nM ³ - mg - g - kg - ton - gal - usgal - igal - lb - bbl - cf - scf - p - rev - °C - °F - °K - % - M - mm - cm - mtr - inch - ft - Yd - psi - psig - mbar - bar - barg - bara - kpa - kpag - inHg - mmHg - mH2O - inH2o - pH - mV - mA - uS - PPM - RPM - no unit - custom (max. 8 characters).
Time units	/sec - /min - /hr - /day - no unit - custom.
Decimals	0 - 1 - 2 or 3.

Percentage

Digits	4 digits.
Decimals	1.

Alarm values

Function	Four user defined alarm values.
Digits	7 digits.
Units	According to the settings of the measuring units.
Decimals	According to the settings of the measuring units.
Type of alarm	Low, high, low-low, high-high or all alarms.
Hysteresis	User defined: Default (disabled), balanced, unbalanced, absolute.
Alarm delay	4 configurable X-time periods to ignore the alarms.
Alarm indication	Configurable alarm text at the display: Alarm, Pump, CTRL, Valve, Level, Relay, Output, Signal.
Protection	The alarm values can be password protected.

	Description	
Model	F190	Multi purpose monitor with analog and high / low alarm outputs.
Input	A	(0)4 - 20mA input.
Analog output	AA	Active 4 - 20mA output - requires XX and PD, PF, PM or PX.
	AB	Active 0 - 20mA output - requires XX and PD, PF, PM or PX.
	AF	I.S. floating 4 - 20mA output - requires XI and PD.
	AI	Isolated 4 - 20mA output - requires XX.
	AP	Passive 4 - 20mA output, loop powered unit.
	AU	Active 0 - 10V DC output - requires XX and PD, PF, PM or PX.
Communication	CB	Communication RS 232 - Modbus ASCII / RTU - requires XX.
	CH	Communication RS 485 - 2wire - Modbus ASCII / RTU - requires XX.
	CI	Communication RS 485 - 4wire - Modbus ASCII / RTU - requires XX.
	CT	Intrinsically Safe TTL - Modbus ASCII / RTU - requires XI.
	CX	No communication.
Enclosures	HB	Aluminum panel mount enclosure.
	HC	GRP panel mount enclosure.
	HSB	Stainless steel 316L panel mount enclosure.
	HD	GRP field mount - Cable entry: no holes.
	HE	GRP field mount - Cable entry: 2 x Ø 16mm & 1 x Ø 20mm.
	HF	GRP field mount - Cable entry: 1 x Ø 22mm (7/8").
	HG	GRP field mount - Cable entry: 2 x Ø 20mm.
	HH	GRP field mount - Cable entry: 6 x Ø 12mm.
	HJ	GRP field mount - Cable entry: 3 x Ø 22mm (7/8").
	HK	GRP field mount - Flat bottom, cable entry: no holes.
	HA	Aluminum field mount - Cable entry: 2 x PG9 + 1 x M20.
	HL	Aluminum field mount - Cable entry: 2 x 1/2"NPT.
	HM	Aluminum field mount - Cable entry: 2 x M16 + 1 x M20.
	HN	Aluminum field mount - Cable entry: 1 x M20.
	HO	Aluminum field mount - Cable entry: 2 x M20.
	HP	Aluminum field mount - Cable entry: 6 x M12.
	HT	Aluminum field mount - Cable entry: 1 x 1/2"NPT.
	HU	Aluminum field mount - Cable entry: 3 x 1/2"NPT.
	HV	Aluminum field mount - Cable entry: 4 x M20.
	HZ	Aluminum field mount - Cable entry: no holes.
	HBM	Extended Alu. field/meter mount - Cable entry: 2 x M16 + 1 x M20.
	HBO	Extended Alu. field/meter mount - Cable entry: 2 x M20.
	HBU	Extended Alu. field/meter mount - Cable entry: 3 x 1/2"NPT.
	HSM	Stainless steel 316L field mount - Cable entry: 2 x M16 + 1 x M20.
HSO	Stainless steel 316L field mount - Cable entry: 2 x M20.	
HSU	Stainless steel 316L field mount - Cable entry: 3 x 1/2"NPT.	
Digital output	OA	Three active transistor outputs - requires XX and PD, PF, PM or PX.
	OR	Two mechanical relay outputs + one OT - requires XX and PF or PM.
	OS	Four mechanical relay outputs - requires XX, AP and PD.
	OT	Three passive transistor outputs.
Power	PD	8 - 24V AC/DC + sensor supply - with XI: 16 - 30V DC.
	PF	24V AC/DC + sensor supply - requires XX.
	PL	Input loop powered from sensor signal type "A" - requires XX, AI and OT.
	PM	115 - 230V AC + sensor supply - requires XX.
	PX	Basic power supply 8 - 30V DC.
Battery	PB	Additional lithium battery powered (optional) - requires XX and PD or PX.
	PC	Additional lithium battery powered (optional) - Intrinsically safe - requires XI and PD or PX.
Hazardous	XI	Intrinsically safe, according ATEX and IECEx.
	XF	Ex d enclosure - 3 keys according ATEX and IECEx.
	XX	Safe area only, according CE / UKCA.
Options	ZB	Backlight - requires XX and PD, PF, PM or PX.
	ZX	No options.

The **bold** marked text contains the standard configuration: F190-A-AP-CX-HC-OT-PX-XX-ZX.