

User Manual

English

Portable Hardness Tester



dmq

QH7

Models C / L / U

Heavy duty

www.demeq.com

QH7 User Manual

Portable Leeb / UCI Hardness Testers

P/N: QHD 701 – ENG – Rev. 01 – November 2017

Index

Introduction

| | | |
|-------------|-----------------------------|-------|
| Leeb | Measuring principle (Leeb) | VII |
| | Selecting the impact device | VIII |
| | Impact device components | XII |
| | Using the impact device | XIII |
| | Loading the impact device | XIII |
| | Release and measure | XIII |
| UCI | Measuring principle (UCI) | XIV |
| | Selecting the UCI probe | XV |
| | Test piece requirements | XVI |
| | Connecting the UCI probe | XVI |
| | UCI probe components | XVII |
| | Using the UCI probe | XVIII |

Chapter 1

First steps

| | | |
|-----|-------------------------------|---|
| 1.1 | Know the QH7 | 1 |
| | 1.1.1 Front panel | 1 |
| | 1.1.2 Connectors | 2 |
| 1.2 | Rechargeable battery | 3 |
| | 1.2.1 Battery level indicator | 3 |
| | 1.2.2 Charging the battery | 3 |
| 1.3 | Special keys | 4 |
| | 1.3.1 The "Q" key | 4 |
| | 1.3.2 Color backlight display | 4 |

Chapter 2

Measuring with the QH7

| | | |
|-----|--------------------------------------|---|
| 2.1 | Measuring screen modes | 5 |
| | 2.1.1 Screen mode-1 (Easy reading) | 5 |
| | 2.1.2 Screen mode-2 (Graphic values) | 6 |
| | 2.1.3 Screen mode-3 (Dist Graphics) | 7 |

| | | |
|-------|--|----|
| 2.1.4 | Screen mode-4 (List values) | 8 |
| 2.2 | How keys work | 8 |
| 2.3 | Set impact device angle (Leeb) | 10 |
| 2.4 | Selecting the material and hardness unit | 11 |

Chapter 3 Menu system and editing

| | | |
|--------|---|----|
| 3.1 | Using the menu system | 13 |
| 3.1.1 | Text editor | 14 |
| 3.2 | Main menu | 16 |
| 3.2.1 | Change hardness units | 16 |
| 3.2.2 | Alarm settings | 17 |
| 3.2.3 | Set histogram range | 18 |
| 3.2.4 | Select language | 19 |
| 3.2.5 | Unit information | 19 |
| 3.3 | General configuration | 20 |
| 3.3.1 | Set time and date | 20 |
| 3.3.2 | Date and time format | 21 |
| 3.3.3 | Set AutoOff time | 21 |
| 3.3.4 | Adjust display contrast | 22 |
| 3.3.5 | Set display color | 22 |
| 3.3.6 | Beep activation | 23 |
| 3.3.7 | Introduction screen | 23 |
| 3.3.8 | Owner information | 23 |
| 3.3.9 | Lock configurations | 25 |
| 3.3.10 | Model upgrade licenses | 26 |
| 3.3.11 | Set factory defaults | 27 |
| 3.4 | Measurement config. options (Leeb) | 28 |
| 3.4.1 | Set impact device angle | 28 |
| 3.4.2 | Select material | 29 |
| 3.4.3 | Create user units | 30 |
| 3.4.4 | Select impact device | 33 |
| 3.4.5 | Impact device alarm | 34 |

| | | |
|-------|---|----|
| 3.5 | Measuring config. options (UCI) | 34 |
| 3.5.1 | Select material | 35 |
| 3.5.2 | Create user materials | 35 |
| 3.5.3 | Indenter dwell time | 39 |
| 3.5.4 | Measuring filter | 40 |
| 3.6 | Measurement config. (Leeb & UCI) | 41 |
| 3.6.1 | The "Plus" key | 41 |
| 3.6.2 | Set group (N) number | 42 |
| 3.6.3 | Select measure mode | 43 |
| 3.6.4 | Set factory defaults | 44 |

Chapter 4 Using the Datalogger

| | | |
|-------|-------------------------------------|----|
| 4.1 | Understanding how data is organized | 45 |
| 4.2 | Memory menu | 46 |
| 4.3 | Create a new file | 46 |
| 4.4 | Actions over single files | 47 |
| 4.4.1 | View data in a single file | 48 |
| 4.4.2 | The "Q" key in a grid | 49 |
| 4.4.3 | The "Q" key in a histogram | 50 |
| 4.4.4 | Rename file | 50 |
| 4.4.5 | Send data in file | 51 |
| 4.4.6 | View file size | 51 |
| 4.5 | Actions on all files | 51 |
| 4.5.1 | Send all files | 51 |
| 4.5.2 | Erase all files | 52 |
| 4.6 | Quick memory menu (Mem key) | 53 |
| 4.7 | Connecting to a PC with DataCenter | 54 |
| 4.8 | Datalogger configuration | 55 |
| 4.8.1 | Configure communications | 55 |
| 4.8.2 | Search for Bluetooth devices | 56 |
| 4.8.3 | Show receiving device | 57 |
| 4.8.4 | Capture modes | 57 |

| | | |
|-------|------------------------|----|
| 4.8.5 | Advanced configuration | 58 |
|-------|------------------------|----|

Appendix

| | |
|---|----|
| Tips on how to measure correctly (Leeb) | 59 |
| Tips on how to measure correctly (UCI) | 63 |
| Technical Specifications | 64 |
| Additional information | 66 |
| Unit maintenance | 66 |
| QH7 accessories | 67 |
| Error messages | 68 |
| Our website: www.demeq.com | 69 |
| Firmware and software updates | 69 |
| Technical support | 69 |

Thank you choosing dmq

And thank you for purchasing a QH7 HEAVY DUTY portable hardness tester.

Company Statement

At Demeq we develop, manufacture and distribute software and quality control instruments offering innovation and solutions that come as a direct result of listening to your needs and demands as a user. We apply some of the latest technology available in the industry to build instruments that are robust, precise and easy to operate.

We are convinced that our products would not be complete without permanent technical and after sales support. So in addition to quality products we offer:

- Quick answers to your inquiries.
- Unlimited access to technical information as well as application notes.
- Firmware and software upgrades at no charge.
- Attention to your inquiries and suggestions.

We hope that the QH7 will meet and exceed your application needs.

General information

Models included in this manual

Information included in this manual applies to the **QH7 HEAVY DUTY** portable hardness tester in all of its 3 models.

Registered trademarks

dmq is a registered trademark of Demeq S.R.L and its affiliate companies.

Important notice

The information contained in this manual is intended to educate users on the operation of the QH7 hardness testers. Failure to read and understand this manual can lead to measurement errors. Decisions based on measurements and or results that are erroneous can lead to property damage, personal injury or even death. Demeq S.R.L assumes no responsibility as a result of improper use of our instruments.

Applicable standards

ASTM A956 and ASTM A1038

User training

Correct use of a QH7 hardness tester requires that you take all of the following into consideration:

- Select the impact device and or UCI probe that is best suited for your application.
- Know the specific requirements for the test you will be conducting.
- Make sure that the person operating the unit has been trained on its use.

This manual provides all of the information needed to configure and operate the QH7 portable hardness tester. However there are additional factors that can affect tests done with this instrument. Specific information on those factors is outside the scope of this manual. When in doubt you should always seek expert advice or refer to specific textbooks on portable hardness testing. Additional information can also be found on the internet and through local government agencies as well as in technical institutes.

Measuring principle (Leeb)

On the Leeb impact rebound method the ratio between the impact and rebound velocities of the impact body that is released on the test piece are measured to establish a Leeb hardness value. This step by step process is represented in figure 1 below: 1 the impact body is released and travels inside the impact device, 2 the impact body hits the test piece, 3 a rebound is generated.

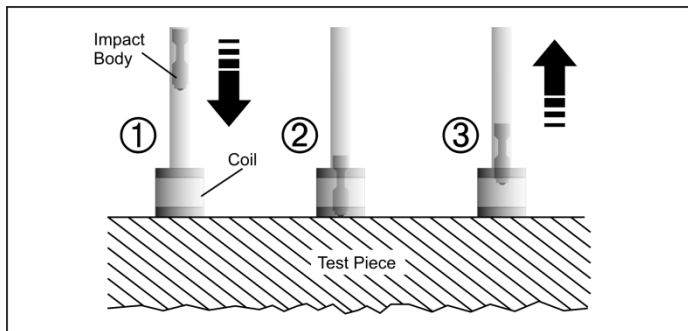

Figure 1: Representation of the Leeb rebound method

The measured Leeb value (HL) represents a direct hardness value that can be converted to other hardness units such as Brinell, Vickers, Rockwell and Shore. Both the HL value and another selected hardness unit are displayed on the unit screen simultaneously.

Selecting the impact device

Choose the impact device that is right for your application. General information including measuring ranges and some of the recommended applications are explained for each impact device. Figure 2 shows a physical representation of each one of the impact device types available for the QH7.

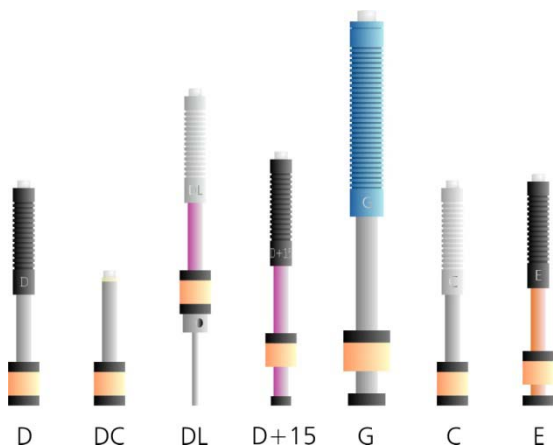

Figure 2: Representation of impact device types (Leeb)

Impact device type D

This is considered the “universal” impact device because it covers the broadest range of hardness units, hardness ranges and materials for the QH7.

Impact device type DC

The type DC impact device is just like the type D except that it features a shorter body (50mm tall) making it ideal for measurements in hard to reach places where a type D impact device cannot be used. And while the type D impact device is spring loaded, the DC impact device is loaded manually.

Impact device type DL

The long and thin tip on type DL impact device allows access to very narrow areas that cannot be measured with any other impact device. This device measures steel only.

Impact device type C

This impact device produces the least amount of energy when compared to all other impact devices (up to 25% less than the type D) making it ideal for measuring heat treated surfaces and small parts. The lower release energy produces a smaller test piece indentation.

Impact device type G

The type G impact device features a carbide ball that is 5mm in diameter and it releases the highest impact energy when compared to all other impact devices (90 N*mm) making it ideal for rough surfaces such as founded or forged parts and grey cast iron.

Impact device type E

The type E impact device uses a synthetic diamond tip (all other impact devices use a tungsten carbide ball). The diamond tip allows measurements on harder parts such as those made out of template steel. This device type measures steel only and extends the Vickers range to 1211HV (device type D measures up to 940HV).

The table below shows detailed technical information on each impact device type.

Impact devices comparison table

| Parameters | Impact Device Types | | | | |
|--------------------------------------|---------------------|------|------|-----|---------|
| | D/DC | DL | C | G | E |
| General Characteristics | | | | | |
| Length (mm) | 147/86 | 202 | 141 | 254 | 155 |
| Diameter (mm) | 20 | 20 | 20 | 20 | 20 |
| Weight (grams) | 75/50 | 100 | 75 | 250 | 80 |
| Max Hardness (HV) | 940 | 950 | 1000 | 650 | 1200 |
| Impact Device Tip or Indenter | | | | | |
| Diameter (mm) | 3 | 2.78 | 3 | 5 | 3 |
| Hardness (HV) | 1600 | | | | 5000 |
| Material | Tungsten carbide | | | | Diamond |

Impact devices comparison table (Continued)

| Impact body | | | | | |
|-----------------------------------|------|-----|------|------|------|
| Energy (N*mm) | 11 | 11 | 3 | 90 | 11 |
| Mass (g) | 5.5 | 7.8 | 3 | 20 | 5.5 |
| Surface test piece requirements | | | | | |
| Roughness ISO | N7 | N7 | N5 | N9 | N7 |
| Rough RT (μm) | 10 | 10 | 2.5 | 30 | 10 |
| Rough RA (μm) | 2 | 2 | 0.4 | 7 | 2 |
| Minimum test piece weight (kg) | | | | | |
| Stand alone | 5 | 5 | 1.5 | 15 | 5 |
| On solid support | 2 | 2 | 0.5 | 5 | 2 |
| Coupled w/ paste | 0.1 | 0.1 | 0.02 | 0.5 | 0.1 |
| Minimum test piece thickness (mm) | | | | | |
| Coupled | 3 | 3 | 1 | 10 | 3 |
| Surface thickness | 0.8 | 0.8 | 0.2 | — | 0.8 |
| Test piece impact indentation | | | | | |
| On parts up to 300HV | | | | | |
| Diameter (mm) | 0.54 | | 0.38 | 1.03 | 0.54 |
| Depth (μm) | 24 | | 12 | 53 | 24 |
| On parts up to 600HV | | | | | |
| Diameter (mm) | 0.45 | | 0.32 | 0.90 | 0.45 |
| Depth (μm) | 17 | | 8 | 41 | 17 |
| On parts up to 900HV | | | | | |
| Diameter (mm) | 0.35 | | 0.30 | — | 0.35 |
| Depth (μm) | 10 | | 7 | — | 10 |

Impact device components

This section provides an overview of basic impact device components.

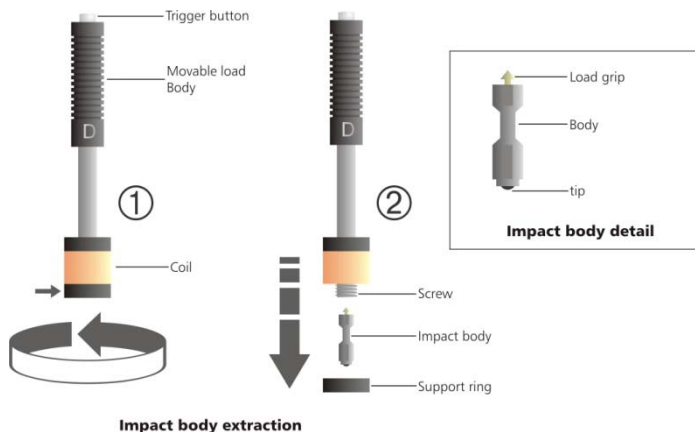

Figure 3: Impact device components

Figure 3 is a representation of the most important parts that make up an impact device and the procedure used to remove the impact body. Over time and depending on the number of measurements that you make, the impact tip located on the impact body must be replaced. In order to do this turn the support ring clockwise (1) until the ring is released and the impact body falls off (2). Make sure you catch the impact body or that you work over a soft surface where the impact body can fall without being damaged. Remove and replace the impact tip making sure everything is clean and repeat the procedure to re-assemble the impact device.

Using the impact device

The procedure explained herein is applicable to all impact device types except for impact device type DC as it does not use a spring loading mechanism.

Loading the impact device

Place the impact device over the surface you want to measure and load by gently pushing the moving body of the impact device in the same direction as the test piece surface. Keep pushing the moving body until you reach the bottom limit and then bring the moving body back to its initial position.

The impact device is now loaded and ready to be used.

Release and measure

Once the impact device has been loaded use one hand to firmly hold the bottom of the impact device (the part that touches the surface you want to measure) against the surface, and use your other hand to press the release button located on top of the impact device.

After pressing the button, the impact tip will hit the test piece surface and a hardness value will immediately be displayed.

Repeat this same procedure for each measurement.



Important

The Leeb method for hardness testing has certain test piece requirements that must be met in order to obtain reliable and accurate measurements.

Measuring principle (UCI)

The QH7 U and C operate on the UCI or Ultrasonic Contact Impedance method of hardness testing where values are obtained by applying constant force to an indenter generating an indentation on the part being tested. But where as in conventional methods such as Vickers, Brinell or Knoop further evaluation is required, with the QH7 readings are processed electronically and instant measurements are obtained in the most common hardness units.

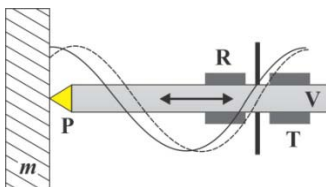

Figure 4: UCI probe

Figure 4 represents a UCI probe where the indenter **P** is a Vickers type synthetic diamond cemented to an oscillating rod **V** which is excited by a transmitting element **T** at a frequency that changes according to the depth of the indentation generated on part *m*. Frequency changes are detected by a receiver **R** and finally the QH7 converts those frequency changes into hardness units using a curve such as the one shown in figure 5.

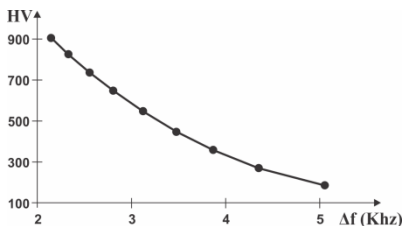

Figure 5: Relationship between hardness and frequency

Selecting the UCI probe

We offer 2 UCI probes with the QH7 that differ in the test loads.

UCI probe part no. QHS010 with a 10N / 1Kgf load

This probe is ideal for surface hardness measurements as well as parts with low roughness and polished surfaces. Recommended for bearings, gear flanges, small die-stamp parts and moulds, etc.

UCI probe part no. QHS050 with a 50N / 5Kgf load

The 50N probe is used to measure hardness on rougher surfaces, cemented parts, pipes, welds, gears, crankshafts and much more.

Test piece requirements

Minimum test piece conditions in order to obtain correct measurements with the QH7 for each type of probe are:

| UCI probe load | 10N / 1kgf | 50N / 5kgf |
|----------------------|----------------------------------|--------------------------|
| Avg. Roughness | 5 μm | 15 μm |
| Curvature radio | >5 mm | |
| Weight | >0,3 kg | |
| Thickness | >5 mm | |
| Indentation Depth | 250HV - 13 μm | 250HV - 29 μm |
| | 750HV - 8 μm | 750HV - 17 μm |
| Surface Layers | > 10 times the indentation depth | |
| Between indentations | >3mm | |

Important



Always clean the surface of the test piece being measured to make sure it is free from oil and grease.

To obtain better results always use the UCI probe perpendicular to the test piece surface.

Connecting the UCI probe



When the UCI probe is connected to the QH7 a message is displayed indicating that the probe has been recognized. Do not measure immediately after connecting the probe as the unit briefly undergoes an auto-calibration process.

Figure 6: Message indicating probe has been connected

UCI probe components

This section briefly explains all of the basic UCI probe components and their intended use.

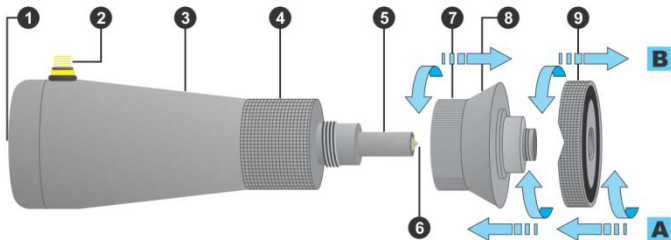

Figure 7: UCI probe components

1. Area where force is applied
2. Cable connector for cable that goes to the QH7
3. UCI probe body
4. Probe holding area (knurled)
5. Bottom end of the probe
6. Vickers indenter (synthetic diamond)
7. Holding accessory
8. Holding area for accessory
9. Adapting ring with 2 sides (flat and "V" cut)

The holding accessory and the adapter are threaded to the UCI probe body (accessory 7 is threaded to the probe and the adapting ring 9 is threaded to accessory 7). In figure 7 threading direction is shown [A] to mount and [B] remove.

Using the UCI probe

UCI probe configuration

Use the UCI probe according to the surface of the part being tested. Choose to use one side of the ring or remove the ring all together.

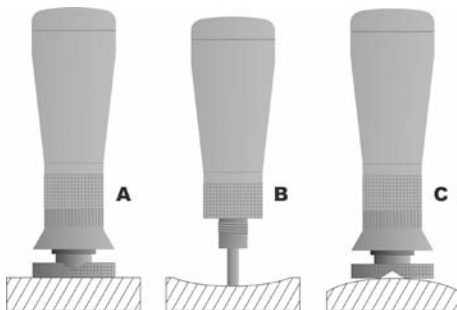
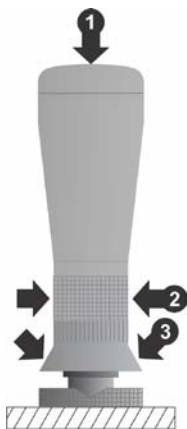

Figure 8: UCI probe configurations

Figure 8 **A** shows the UCI probe with the flat side of the support ring to measure on flat surfaces. In **B** the ring has been removed to measure over a concave surface (also used to measure in hard to reach areas, weld joints, etc). On **C** the probe is mounted with the "V" side of the ring which is used to measure convex surfaces.



When you are ready to measure force must be applied on the UCI probe that has been ergonomically designed for comfort of use and ease of operation. The 3 points in figure 9 show the positions to better hold and use the probe: **1** (top of the probe) is a large and “soft” area where you should place the palm of your hand to gently push down, **2** lets you hold the probe so it doesn’t slide off your fingers or away from the test piece, **3** allows you to hold and push down using fingers from both hands. Using the UCI probe with one hand only is also possible but not recommended.

Figure 9: How to apply force

For best results use the support ring in order to maintain the probe vertical and stable when force is applied. If you need to remove the ring due to the geometry of the part being tested we suggest that you use both hands to hold the probe.

Measuring: preloading and loading

For best results always apply force as follows:

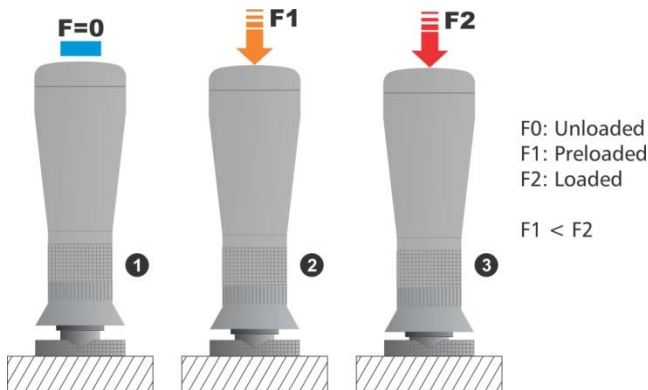

Figure 10: Preloading and loading the probe

Set the probe on test point 1. Apply a preload force (indenter will go “half way” into the test piece 2). Apply full force to finish loading 3.



Figure 11: Instructions in measuring screen

When measuring the unit will also display 3 messages as follows: 1 Apply force to probe, 2 “Hold force and wait...”, 3 Lift probe. For best results follow the prompts for every measurement.

Important: Safety Information

QH7 portable hardness testers are for industrial use only and cannot be used in medical applications.

The QH7 operates with two rechargeable “AA” Nickel-Metal batteries. Disposal of your QH7 or any of its components must be done in compliance with your local applicable regulations.

About our Software

Because software is complex in nature and errors may eventually appear you should check that functions required for your application are working correctly.

Warranty

Demeq provides a limited 5 (five) year warranty on electronic units and 6 (six) months on probes from the date of purchase.

Please remember to register your unit at:

<http://www.demeq.com/Contact.html>

Every instrument manufactured by Demeq undergoes thorough testing during the manufacturing process and a final quality control check is done when certificates are issued.

In the event that warranty service becomes necessary please contact your local distributor or Demeq directly. We will solve your problem in the shortest amount of time possible.

Remember that shipping charges for warranty repairs or parts under warranty are always the customer’s responsibility.

1 First steps

1.1 Know the QH7

1.1.1 Front panel



Figure 1.1: Front panel

1. Lemo type 00 connector for UCI probe
2. Lemo type 0B connector for impact devices
3. USB mini to connect to PC / battery charger
4. Graphic LCD display with multiple color backgrounds
5. Scroll left key / View partial statistics (Stat)
6.  key: Shortcut to return to the measuring screen from all unit menus / User assigned key (shortcut)
7. Scroll right key / Change measuring modes / screens (View)
8. Menu key / Exit and return to measuring screen / Exit and return to menu (Home)

9. Enter key / Change values in the measuring screen (Edit)
10. Set backlight illumination (On, Off, Auto)
11. Scroll down key / Quick access to screens with memory options (Mem)
12. **Q** key: On Off (hold for 2 seconds) / Special functions
13. Scroll up key / Store measurement manually (Store)

1.1.2 Connectors



Figure 1.2: Connectors

1. Lemo type 00 for UCI probe
2. Lemo type 0B for impact devices
3. USB mini to connect to PC / battery charger
4. Bluetooth antenna



Important

In order to avoid probe recognition errors always connect one probe at any given time. Do not connect the impact device and the UCI probe together.

1.2 Rechargeable battery

1.2.1 Battery level indicator

The QH7 operates on (2) "AA" rechargeable batteries that can be charged using the USB connector in the unit. Depending on the current released by the charger and the state of the battery the unit adjusts for different charges:

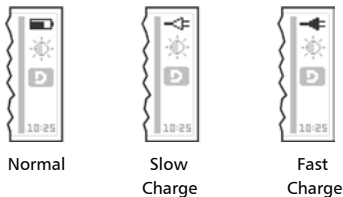

Figure 1.3 Battery state icons

When the unit is not being charged the battery indicator shows the battery level (Normal).

1.2.2 Charging the battery



The QH7 can be charged in one of several ways; using the USB port from a PC, with a standard 5V power supply, or any 1,5 amp power supply. Always try to use a USB cable that is less than 1 meter in length to ensure faster charges. The charger can be connected even when the QH7 is being used.

A full charge in fast mode takes about 3 hours while a slow charge can take up to 14 hours. Once batteries are charged the unit will automatically stop the charging cycle.

1.3 Special keys

1.3.1 The “Q” key

The  key has three functions:

1. When the unit is off, touch  for 2 seconds to power on the unit.
2. When the unit is on, touch  for 2 seconds to shutdown the unit.
3. With the unit on, making short touches to the  will activate special functions described in each chapter of this manual.

1.3.2 Color backlight display

Backlight illumination options can be changed from any screen in the unit.

Touch  to change backlight illumination settings.

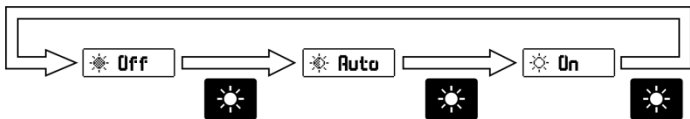



Figure 1.4: Backlight illumination options

To change backlight color see page 22.

Use of the backlight reduces battery life so when the battery is low the backlight illumination is turned off in order to extend battery life.

2 Measuring with the QH7

The QH7 can display measurements in 4 different modes or screens that show specific information. To switch screens touch the  key.

2.1 Measuring screen modes

2.1.1 Screen mode-1 (Easy reading)

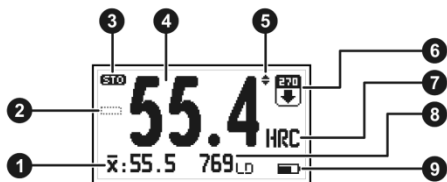

Figure 2.1: Screen mode-1

1. Average hardness value in the hardness unit selected by the user
2. + (plus) or – (minus) measured value indicator as it relates to the nominal value in differential mode
3. Icon indicating that a value has been stored
4. Hardness value in the selected hardness unit
5. Impact indicator (Leeb only)
6. Impact angle (Leeb) and probe load (UCI) indicator
7. User selected hardness unit

8. Leeb hardness value and impact device type / Number of N values for real time statistics (UCI)
9. Battery level indicator / charger

2.1.2 Screen mode-2 (Graphic values)

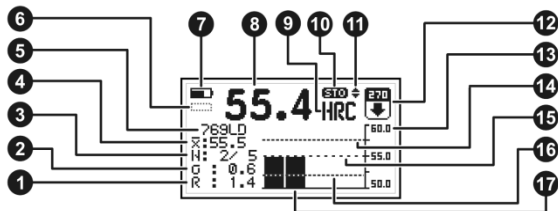

Figure 2.2: Screen mode-2

1. Group range
2. Group standard deviation
3. Number of (N) values indicator for real time statistics
4. Average hardness value in the hardness unit selected by the user
5. Leeb hardness value and impact device type
6. + (plus) or - (minus) measured value indicator as it relates to the nominal value in differential mode
7. Battery level indicator / charger
8. Hardness value in the selected hardness unit
9. User selected hardness unit
10. Icon indicating that a value has been stored

11. Impact indicator (Leeb only)
12. Impact angle (Leeb) and probe load (UCI) indicator
13. Graphic reference values for the selected hardness unit
14. Graphic line high alarm
15. Graphic line group average
16. Graphic line low alarm
17. Actual group value graphics

2.1.3 Screen mode-3 (Distribution graphics)

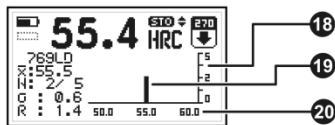

Figure 2.3: Screen mode-3

18. Graphic line for number of samples
19. Actual group value graphic/s
20. Graphic reference values for the selected hardness unit

2.1.4 Screen mode-4 (List values)

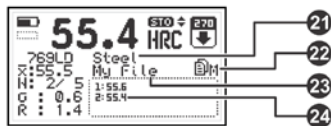

Figure 2.4: Screen mode-4

21. User selected material
22. Datalogger mode indicator: X: Off - M: Manual - A: Auto
23. Name of the open file where values are being stored
24. Actual values within group

2.2 How keys work

Keys in all four measuring modes have the following functions:



: Manually store measurement in the memory



: Change measuring modes / screens



: Exit measuring screen and enter main menu



: Access quick memory options menu



: Press to access the select / edit mode. A "floating menu" appears on the unit screen to set angle, hardness unit and material.

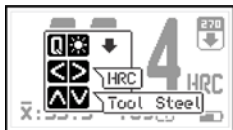

a: Settings including angle



b: Settings without angle (auto)

Figure 2.5: Select / Edit screen

On “dmq” impact devices the angle is set automatically (Figure 2.5b).

To change the impact device angle press the and keys.

To switch hardness units press the and keys.

To change material press the and keys.

To save and exit press or press to exit without making any changes.



: Change real time statistical data within the group as seen below.



Figure 2.6: Statistical data

Statistical data includes: Mn: min / Mx: max values, G: standard deviation, R: range, G%: stand deviation and R%: range percentages based on average value and Pos: position in the Datalogger.



Note

Statistical information does not change in screen mode-1 "Easy reading".



: Press for 2 seconds or more to turn unit off.



: Change backlight illumination







: Enter direct access function established by the user

2.3 Set impact device angle (Leeb)

If you operate the QH7 with a generic brand impact device the angle in which the impact device will be used must be set manually. Remember that setting the impact device angle is important in obtaining precise measurements.

The QH7 offers three ways of changing the impact device angle:

- From the measuring screen press  to enter the select / edit mode and press  -  to select the angle. Press  to save.
- Press the  key as long it was set to Angle in the direct access options that can be set for this key (Page 41).
- From the hardness configuration menu under Angle (Page 28).

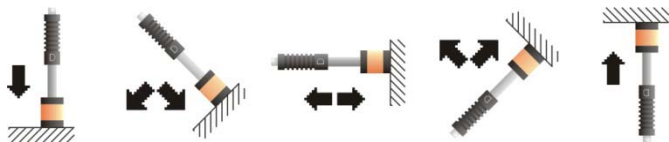





Figure 2.7: Icons corresponding to the impact device angles

When using dmq impact devices featuring GyroTag technology the QH7 automatically recognizes the impact device angle allowing you to always obtain precise measurements. The user can now measure complex parts in different angles without having to worry about the impact angle.





2.4 Select material and hardness unit

Material and hardness unit options depend on the impact device that is connected to the unit. Before measuring make sure that the impact device you will be using meets your needs in terms of the material, hardness unit and hardness range in which you want to measure.

The QH7 offers two ways to change the material:

- From the measuring screen in mode-4 (Page 8) press  to enter the select / edit mode and press  -  to select the material. Press  to save and exit.
- From the hardness configuration menu under Material (Page 29).

The QH7 offers three ways to change hardness unit:

- On the numerical measuring screen press  to enter the select / edit mode and press the  -  keys to select hardness unit. Press  to save and exit.
- Press the  as long it was set to Unit in the direct access options that can be set for this key (*Page 41*)
- From the main menu under Unit (*Page 16*)

For detailed information on all of the possibilities in terms of the materials, hardness units and hardness ranges in which you can measure, please refer to the tables in the Appendix "Tips on how to measure correctly"

Important

When changing hardness units the (N) number of values is reset to zero and all previous values in the group are lost.

When changing materials the hardness unit is automatically set to Leeb.



3 Menu system and editing

3.1 Using the menu system

The instructions explained in this chapter apply to all of the menus in the unit.

To scroll QH7 menu options use the **▲**-**▼** cursor keys. When you reach the end of the menu and move to the next menu option it becomes circular as shown herein.

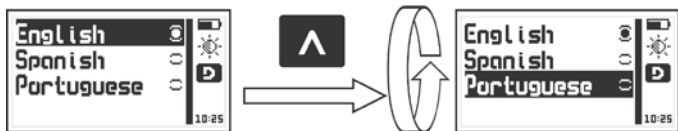

Figure 3.1: Example of how a circular menu works

To select a menu option touch **↵** and to exit and return to the previous menu touch **🏠**.

To go to the measuring screen touch **🏠** from the main menu, or touch **+** from any other menu in the unit.

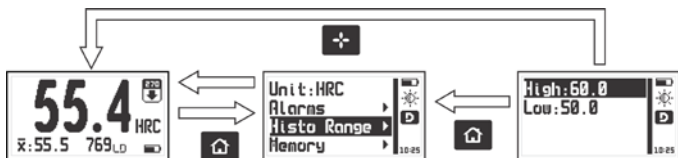

Figure 3.2: Ways of going to the measuring screen

3.1.1 Text Editor

The text editor is used to input, modify and delete; letters, numbers and symbols.



Figure 3.3: Alphanumeric editor screens

1. Selected key
2. Cursor
3. Text to be edited
4. Virtual keyboard

Use the cursor keys to scroll the virtual keyboard until you find the character that you want to use and press  to select.

Press the  key to move to the upper case virtual keyboard and to the numbers and symbols keyboard as seen on figure 3.3.

There are 4 keys that are common to all virtual keyboard screens:

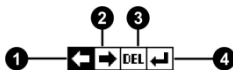



Figure 3.4: Common virtual keyboard keys

1. Move cursor to the left
2. Move cursor to the right
3. Delete character on which cursor is on
4. Enter and exit

Press the  key to open the direct access keyboard to the most commonly used virtual keyboard keys. Each virtual key corresponds to a key on the front panel of the unit as follows:

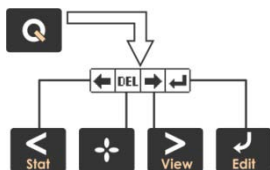

Figure 3.5: Quick access keys for the virtual keyboard editor



: Move cursor to the left



: Delete character on which cursor is on



: Move cursor to the right



: Enter and exit

To close the direct access keyboard and continue using the virtual keyboard press .

3.2 Main menu



The main menu is the first list of options you see when you exit the measuring screen and includes some of the most important settings.



Touch  from the measuring screen to access this menu.

Figure 3.6: Main menu

Note: The "Memory", "Configure" and "Hardness" options are explained later on in this manual.

3.2.1 Change hardness unit

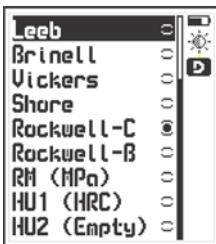

Press  on **Unit** in the main menu to open the list of available hardness units.

Use the  -  keys to scroll the menu.

Press  to select the hardness unit.

Press  to save and exit this menu

Figure 3.7: Hardness units menu

Notes



The units in (Figure 3.7) correspond to a type D impact device. Remember that hardness units depend on the impact device that is connected to the unit (Appendix, Page 61).

Hardness units HU1 and HU2 are user units available in Leeb only (Page 30).

3.2.2 Alarm settings Alarms

The QH7 has high and low alarm conditions that alert the operator when a measurement is greater than the value set for the high alarm and or when a measurement falls below the value set for the low alarm.

Press  on **Alarms** to open the alarm menu options.



Press  on **High** or **Low** to open the numbers editor where you can set alarm values using the cursor keys.

Press  to save the alarm value that you entered and to return to the previous menu.

Figure 3.8: Alarms menu options

Alarm types that you can choose include:

Color High : Set a display color associated with the high alarm. To set the display color see “3.3.5 Set display color” (Page 22).

Color Low : Set a display color associated with the low alarm.

Beep: Audible intermittent alarm type.

Back Color: Activates Color High/Low Alarm event.

Screen: Visible alarm that causes measurements to be displayed in dotted instead of regular numbers.

Light: Visible alarm that activates the display backlight illumination causing it to flash

3.2.3 *Set histogram range*

Histo Range

Here you can set high and low hardness range values that will be represented on the vertical axis of the graphical measuring screen mode-2 and on the horizontal axis in screen mode-3.



Histogram range menu

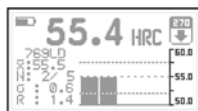



Screen mode-2



Screen mode-3

Figure 3.9: Set histogram range values

Press  on **Histo Range** to open the histogram menu.

Press  on **High** or **Low** to open the numbers editor where you can set values using the cursor keys. Then press  to save and return to the previous menu.



Note

When changing the hardness unit the histogram range changes to default values for the hardness unit that you selected.

3.2.4 *Select language*

Language

Press  on language (which is also identified with a flag) to view available language options.



Use the cursor keys to navigate available language options and touch  to select.





Touch  to save and exit this menu.

Figure 3.10: Language menu options

3.2.5 *Unit information*

Unit Info

Select **Unit Info** to view information including owner data, software and hardware versions and other complimentary information for your unit.

To switch information screens press the  -  keys and press  to return to the main menu.

| | | | |
|--|--|---|--|
| Name Phone MailName@ MailDomain | dnr QH7-C Serial:00128 Hard:002-002 Date:28/03/17 | Soft:1.01.008 28/09/17 OS: 1.02.003 18/03/17 | VM: 001.019 BDev:00001 HDev:00008 (V) Addr:00 |
|--|--|---|--|

Figure 3.11: Unit information screens



Note

If you purchase a model upgrade license we will ask for information available on the unit information screens. .

3.3 General configuration

Configure

Touch  on the **Configure** option to open the general configuration options menu.

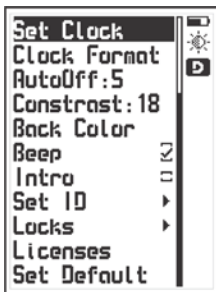

Use the  -  keys to scroll the menu.

Touch  to select any of the menu options.



Touch  to exit and to return to the previous menu.

Figure 3.12: General configuration menu

3.3.1 *Set time and date*

Configure » Set Clock

Choose **Set Clock** to open the time and date editor. Use the cursor keys to set the time and press  to save and enter the date editor screen. Set the date and press  to save and exit.

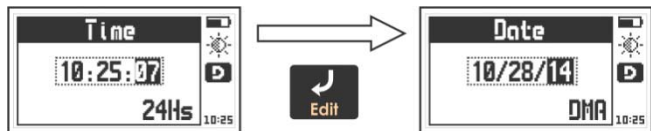
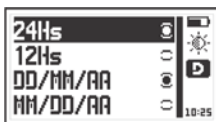

Figure 3.13: Time and date edit screens

3.3.2 *Date and time format* Configure » Clock Format

Choose **Clock Format** to open the menu that allows you to set the time format (12Hs or 24Hs) and the date format (D/M/Y – M/D/Y).





Touch  on the option you wish to select and touch  to save and exit.



Figure 3.14: Date and time format menu options

3.3.3 *Set AutoOff time* Configure » AutoOff

The unit will shutdown automatically if no key is pressed or no measurement is made after a time set by you.

Touch  on **AutoOff** to set the time for the unit to automatically shuts down.



Touch the  -  keys to set the time and touch  to save and exit.





Touch  to exit without changes.

Figure 3.15: AutoOff time setting screen

3.3.4 *Adjust display contrast*

Configure » Contrast

Contrast settings allow you to turn the unit screen lighter or darker where 1 is the lightest and 32 is the darkest.

Touch  on **Contrast** and use the  -  keys to change the contrast on your screen.

Touch  to save or touch  to exit without making changes.



Figure 3.16: Screen contrast settings





Tips

Contrast on LCD screens can change with temperature. Use the contrast option to compensate for changes caused by temperature to maintain optimal viewing conditions.

3.3.5 *Set display color*

Configure » Display Color

Press  on **Display Color** to change the display background color on your QH7 using three bars that correspond to each one of the three basic colors (R:red, G:green and B:blue).

Use the  -  keys to adjust the selected color (flashing

indicator) and use the  key to change between the three basic colors options (R,G,B).





Press  to enter and exit, or press  to exit without changes.

Figure 3.17: Display background color settings

3.3.6 *Beep activation*

Configure » Beep

Beep refers to the sounds that the unit makes when keys are touched and when the audible alarm is active.

Touch  to enable or disable the beep option.

3.3.7 *Introduction screen*

Configure » Intro

The introduction screen is the first screen that you see when the unit is turned on and includes owner information such as name, telephone number and e-mail.

Touch  to enable or disable this option.

3.3.8 *Owner information*

Configure » Set ID

This option allows you to enter owner information (the info that would appear on the introduction screen).

Press  on **Set ID** and enter the factory default password which is

12345 and press  again to access owner info menu options.

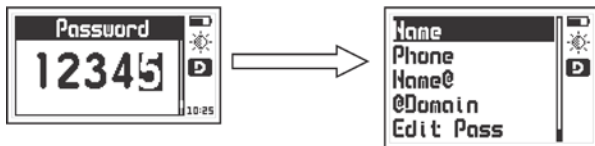

Figure 3.18: Enter password and owner information menu

The following owner information can be entered / changed:

Name: Set or change the owner name.

Phone: Set or change the telephone number.

Name@: Set or change the e-mail (before the @).

@Domain: Set or change the domain for the e-mail (after the @).

Edit Pass: Allows you to change the password needed to access this menu.

Notes

To enter or change text see page 14.

When showing user information the e-mail address is displayed as "Name@Domain".



Important

The factory default password is 12345. You can change this password after adding your user information.

3.3.9 *Lock configurations*

Configure » Locks

Certain configuration options on the QH7 unit can be locked in order to avoid unwanted changes. Use of the locking options allow a supervisor to optimize unit configuration settings required for a specific test and then pass the unit on to an operator for him or her to conduct the actual measurements knowing that the unit has been properly configured and that the settings cannot be changed.

Press  on **Locks** and enter your password. Then press  again to view the configuration options that can be locked.

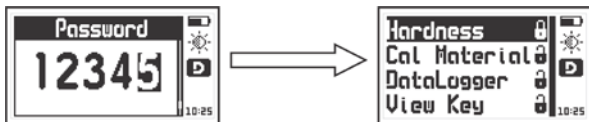

Figure 3.19: Lock configuration options

Each option is followed by a lock indicating whether the feature is locked (closed lock) or unlocked (open lock).

Touch  on each of the following options to lock or unlock:

Configure: Lock or unlock hardness configuration options (Angle, Material, Hardness Unit)

Cal Material: Lock or unlock the option for creating new materials in UCI mode

DataLogger: Lock or unlock datalogger configuration options

View Key: Lock or unlock the view key to change measuring screens

3.3.10 *Model upgrade license*

Configure » Licenses

QH7 models can be changed with software licenses. If you want to purchase a model upgrade license we will ask you for the following information:

- Unit model
- Unit serial number
- The type of license that you would like to purchase

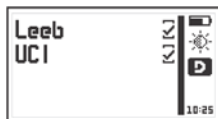



Press  on **Licenses** to view all licenses available for your unit (checkmarks indicate active licenses).

Figure 3.20: Licenses screen

To enter the new license number that you purchased press  or to exit and return to the previous screen press .



Use the cursor keys to enter the license number and touch  to save.

Figure 3.21: Enter license screen

After you enter the new license number the unit will respond with one of the following messages:



Wrong license password message



Correct license password message

Figure 3.22: Response messages after a license is entered

If the license number that you entered is correct the unit will show an updated license screen where the newly purchased license appears followed by a checkmark.

The QH7 allows for two licenses: Leeb and UCI (L and U models). When both licenses are marked the unit is a C or combined model.

3.3.11 *Set factory defaults*

Configure » Set Default

Choose **Set Default** to return to the original factory default general configuration options.

Press  and a confirmation screen will appear.





Press  to confirm and return to the previous menu or press  to exit without making changes.

Figure 3.23: Set factory default settings confirmation screen

3.4 Measuring configuration options (Leeb) Hardness

Choose **Hardness** from the main menu to view all Leeb measuring configuration options

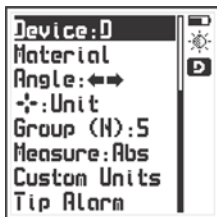

Menu options using a generic impact device

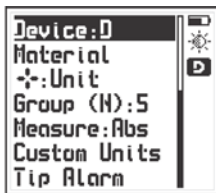

Menu options using a dmq impact device

Figure 3.24: Measuring configuration options menu (Leeb)

Setting these options correctly is critical in obtaining reliable measurements. When using dmq impact devices with GyroTag technology the option to change Angle does not appear in the menu.

3.4.1 Set impact device angle (Leeb) Hardness » Angle

Press  on Angle to select the angle for the impact device.

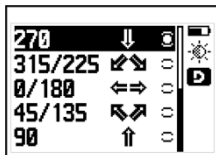

Use the  -  keys to scroll all menu options and touch  to select.

To exit without making changes touch .

Figure 3.25: Set Impact device angle menu

The angle you select will show on the measuring screen with the corresponding icon.



Note

Options to manually change the impact device angle will appear only when generic impact devices are connected to the QH7. For all dm_q impact devices with GyroTag technology all change angle options will not appear.

3.4.2 *Select material (Leeb)*

Hardness » Material

Press  on **Material** to select the material that you will be testing. The material types that appear on the unit screen depend on the impact device or UCI probe connected to the unit. For more details refer to the appendix (page 61 for Leeb and 65 for UCI).



Use the  -  keys to scroll all menu options and touch  to select.

To exit without making changes touch .

Figure 3.26: Materials menu

3.4.3 Create user units (Leeb) Hardness » User Units

The QH7 allows you to create two user units to measure materials such as special alloys that are not included in the materials menu. User units are created using test piece samples of known hardness values for the material that you want to create.



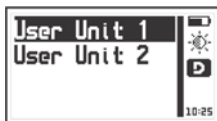

After selecting material and hardness unit press  on **User Units**

Figure 3.27: User unit menu

Choose one of the user units pressing  (user unit 1 or 2 makes no difference) and enter the first reference point:

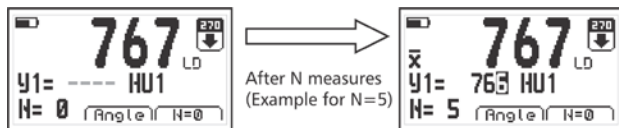



Figure 3.28: First user unit reference point

To enter the first reference point make (N) number of measurements on the test piece sample for the alloy of a known hardness value.

Two options will appear on your unit screen:

N=0: Use the  key to reset the counter to 0 if a wrong measurement was taken.

Angle: Use the  key to change the impact device angle.

Each measurement will appear on the unit display with large numbers until the N number of samples is completed. When this happens an \bar{x} symbol will appear indicating that the value on screen is the average of the N measurements. Right below the average value the number that appears after **Y1=** can be changed to match the known hardness value of the test piece sample.

When you press  the new reference point will be saved and the menu will change giving you two new options:

Other: Press  to add another reference point to the newly created unit.

Ready: Press  to finish the process for creating a new user unit.

User units created with one reference point are precise only to measure test pieces with very similar hardness values.

In order to extend the measuring range for a newly created user unit we recommend that another reference point be added using a second test piece sample of a known hardness value.

Press  to add **Other** (another reference point) and the following screen will open:

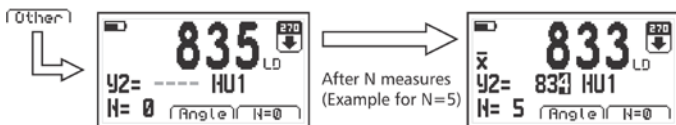
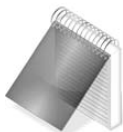

Figure 3.29: Second user unit reference point

To enter the second reference point, follow the same procedure that you used to enter the first one.

User units are called HU1 and HU2. In the hardness unit selection menu, newly created user units will be followed by the hardness unit that they were based on. So if for example HU1 was created using the Rockwell C (HRC) hardness unit, HU1 will be displayed as HU1 (HRC). Available user units are followed by (Empty).



Notes

When a user unit is created using two reference points the first point must be of a lower hardness value than the second point or the operation will be automatically cancelled.

Even though a user unit has a different name (for example a user unit created using the Brinell (HB) hardness unit would be HU1 (HB), measurements done with this user unit will display hardness values in (HB) only.

User units are only available for the material in which they were created. So for example if a user unit was created using steel, and you change to stainless steel, the user unit will be displayed as (Empty).

The (N) number of values used to generate reference points is set in Group (N).

Important





Since user units are created to measure alloys they will most likely present a greater degree of error when compared to measurements done using standard materials included in the unit. To know how precise a user unit really is you should work with several test piece samples of known hardness values that when measured should give you a very similar error that now becomes a known factor.

3.4.4 *Select impact device (Leeb)* Hardness » Device

Press  on **Device** to open the impact device list. Keep in mind that this menu is available only for Leeb or Combined models.



Use the  -  keys to manually choose the impact device connected to the QH7 and press  to select.

To exit press .

Figure 3.30: Impact device selection menu

When **Auto** is selected dmq impact devices featuring GyroTag or CalTag technology will be automatically recognized when they are connected to the QH7.

When selecting the impact device type manually make sure that the impact device corresponds to the same type that is connected to the unit.

3.4.5 *Impact device alarm (Leeb)*

Hardness » Tip Alarm

The tip on the impact device is a tungsten carbide ball subject to wear that is progressive and will most likely affect unit accuracy. If you are getting erroneous readings the tip is probably worn or damaged and needs to be replaced. The **Tip Alarm** feature reminds you to check the unit using a known test block every. We recommend that this be done every 500 impacts.



Select **Every**: to set the alarm limit (default value is 500) and use **Reset** to set the counter back to zero each time the carbide ball or entire impact device are replaced.

Figure 3.31: Set impact body counter alarm menu

Uses show the accumulated number of impacts and **Control** de partial number of impacts –go to 0 with **Reset**-.

3.5 *Measuring configuration options (UCI)*

Hardness



In UCI mode select **Hardness** in the main menu to view measurement configuration options.



To obtain accurate results make sure to set these options correctly.

Figure 3.32: Measuring configuration options menu (UCI)

3.5.1 *Select material (UCI)*

Durometro » Material

Touch  on **Material** to select the material that corresponds to the part that will be tested. Units are calibrated from factory to measure steel and additionally another 7 materials can be generated by the user with samples of a known hardness value.

Use the  -  to scroll all menu options and touch  to select.

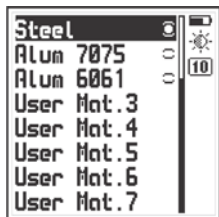

To exit without changes touch .

“Alum 7075” and “Alum 6061” in figure 3.21 are only examples of 2 materials created by the user.

Figure 3.33: Materials menu

3.5.2 *Create user materials (UCI)*

Hardness » Cal Material

With the QH7 you can create up to seven user materials. To create a new material you need test piece samples of the same material that you want to create and they must be samples of a known hardness value.

Touch  on **Cal Material** and the following menu will appear:

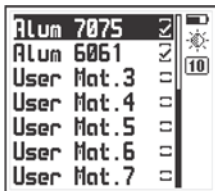

This menu shows the seven user materials, where those that have already been defined appear as selected (“Alum 7075” and “Alum 6061”). Undefined materials show unmarked. To edit or create a new user material press .

Figure 3.34: User materials menu



To begin adding a new user material press  on **Calibrate** and a menu will be displayed with standard base materials.

Figure 3.35: New user materials menu

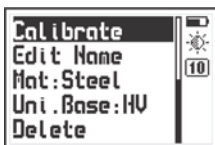

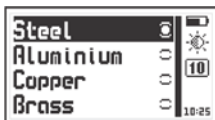

Choose the base material that is closest to the material of the test piece samples and press . Then press  to continue.

Figure 3.36: Base material menu



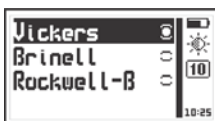

Then choose the hardness unit that must be the same as that of the test piece samples. To select the unit press  and then press  to continue.

Figure 3.37: Hardness units menu

Hardness unit options will change according to the base material that you selected previously. Figure 3.25 shows units for aluminum.

After selecting the base material and hardness unit a name can be given to the newly created material. Press  on **Edit Name** to give the new material a name or simply move on to the next step to keep the default name.

The last and most important step is to enter the hardness values of the test piece samples

To begin this process touch  on **Calibrate**.

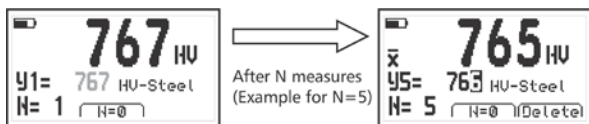



Figure 3.38: First calibration point for the user material

To enter the first calibration point for the new user material make N number of measurements on a calibration test block of a known hardness value. The N number is set in Group (N).



The following two options are displayed on the calibration screen:

N=0: touch the  key to reset the N number of samples in case of erroneous measurements

Erase: touch the  key to erase the last measurement

Single values will be displayed with large numbers and when the N number of measurements is completed the \bar{x} symbol will appear showing the average for the N number of measurements. In the line marked **y1=** the hardness value can be edited so that it matches the value of the test piece sample being measured.

Press  to accept the first calibration point and two additional options will be displayed as follows:

- **Other** : press the  to add another calibration point
- **Ready** : press the  to finish setting up the new user material with just one calibration point

When a new material is created using one point calibration only displacement for the base material that you selected can be generated and is known as a grade 0 (zero) equation that could be insufficient to obtain reliable readings. In this case a second test piece of the same material but different hardness value should be used to generate another calibration point.

Press  to select "Other" in order to create another calibration point.

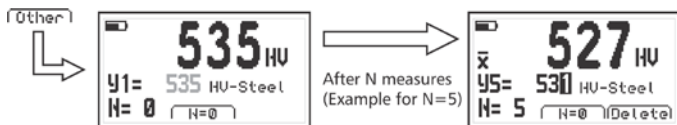

Figure 3.39: Second calibration point for the user material

To enter a second calibration point follow the same steps used to for the first calibration point.

A new user material can be calibrated with up to 4 different test piece samples or calibration test blocks.

Once the material has been created it will appear on the user materials menu as selected (figure 3.22) meaning that the unit has been calibrated for the new material. The new material will also be

displayed in the materials menu.

To erase a user material go to **Delete** in the new user materials menu. Keep in mind that the name is kept unless you change it.



Notes

By default user materials that have not been created are listed as "User Mat. X".

The number of (N) samples used for calibration is set in **Group (N)**.

User materials can be protected from deletion using lock configuration options.

3.5.3 *Indenter dwell time (UCI)*

Hardness » Dwell Time

Dwell Time allows you to set the time that it takes the unit to display a reading after force has been applied on the probe.



Use the **▲** - **▼** keys to set the time (milliseconds) and touch **↵** to save and exit.

Touch **🏠** to exit without changes.



Figure 3.40: Set dwell time

3.5.4 *Measuring filter (UCI)* Hardness » Filter

This option allows you to set a measuring filter so that noisy or erroneous measurements are discarded. In practice this means that obtaining precise readings takes more time as extra care must be taken when preloading the probe. Force must be applied gently without “hitting” the probe on the part being tested.

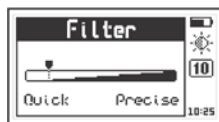
When a measurement doesn't meet the filter criteria the unit discards that measurement and a message reading “MEASURE FAILURE!” shows in the unit display.



Touch  -  to set the filter and touch  to save and exit.

Touch  to exit without changes.

Figure 3.41: Measuring filter



Important

Keep in mind that setting the filter for more precision means extra care particularly when measuring soft non-ferrous materials or steel under 400HV.

3.6 Measuring configuration (Leeb & UCI) Hardness

To set configuration options for both Leeb and UCI modes select **Hardness**.

3.6.1 The "Plus" key Hardness »

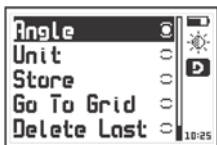

In the measuring screen the  is used as a shortcut for direct access to any of the options below as configured by you.



Press  on  to view and select quick access options.

Figure 3.42: Menu options for the "Plus" key

Quick access options are as follows:

Angle: Change impact device angle (option not available when using dmq impact devices and when working in UCI mode)

Unit: Change hardness unit

Store: Use to manually store values

Go To Grid: Go to the grid in the open file

Erase Last: Erase the last value saved in the datalogger

3.6.2 *Set group (N) number* Hardness » Group (N)

In order to obtain reliable measurements with your QH7 we suggest taking at least three measurements within 3 to 4mm from one another and using the average of these three values as your final hardness measurement. Set the group (N) number which is the number of values that will be used for averaging.

The (N) number is also used to generate other statistical data and to set the number of columns in the Datalogger. Every (N) number of values statistical data for the group is automatically updated and the group is closed in the Datalogger.

Partial statistics can be viewed at anytime by pressing the  key.





Press  on **Group (N)** to open the numbers editor where you can set the (N) number and then press  to save and  to exit.

Figure 3.43: Set group (N) value



Note

When the hardness unit is changed the group (N) number is automatically reset to zero. The group that was open in the Datalogger is automatically closed and a new group is opened.

3.6.3 *Select measure mode* Hardness » Measure

Press  on **Measure** to open the measure modes options menu.

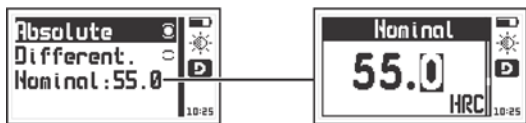





Figure 3.44: Measure mode options menu and set nominal value

The modes in which measurements can be made are:

Absolute: The unit displays the real measured value.

Differential: The value displayed is a result of the value obtained from calculating:

$$\text{Differential} = \text{Real value} - \text{Nominal value}$$

The nominal value is a reference value for the test piece. Press  on **Nominal** to set a value and press  to save. To exit without making any changes press .

3.6.4 *Set factory defaults*

Hardness » Set Default

Choose **Set Default** to return to factory default hardness configuration settings.

Press  and a confirmation screen will appear.





Press  to confirm and return to the previous menu or  to exit without making changes.

Figure 3.45: Set factory default confirmation screen

4 Using the Datalogger

4.1 Understanding how data is organized

In order to optimize the use of the Datalogger in your QH7 you first need to understand how data is organized. Up to 8 individual files with alphanumeric names can be used to store data. Each file contains a grid with columns and rows and each grid contains columns identified with consecutive letters (A, B, ...AA, AB...) that store a number of values set in Group (N). Each value is identified with a column letter and a row number.

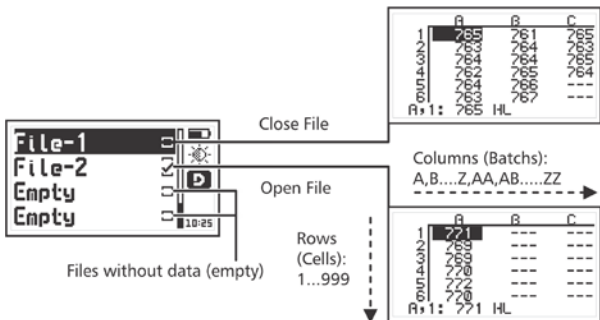

Figure 4.1: How data is organized

The location of a value is always represented as a "Batch, Cell" so for example F,7 means that the value is in column / batch F, row / cell 7.

The number of measurements in a batch is set in **Group (N)**. Each time this number is reached the batch automatically closes and a new one is opened. When (N) is changed the number of measurements changes but without closing the file which allows for different size batches within a single file.

4.2 Memory menu



Select **Memory** from the main menu to view all menu options for the Datalogger. This chapter explains how to create, organize and view files

Figure 4.2: Memory menu

4.3 Create new file

Memory » Files » "Empty"

Press  on **Files** and use the cursor keys to see the list of files in the unit.

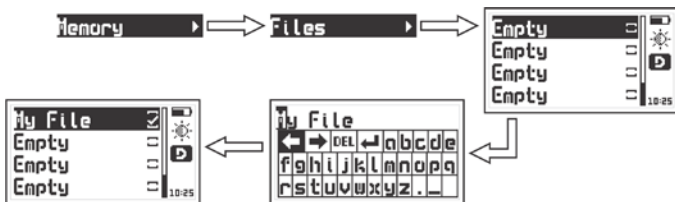



Figure 4.3: Creating a file

Select a file that appears as **Empty** and press  to name the file with up to 10 alphanumeric characters.

After you enter a name a checkmark will appear meaning that a new file has been created and is ready to be used.

Remember that only one file can be open at any given time so when a new file is created if another file was open it will be automatically

closed. Once a file has been closed it cannot be reopened and new values can no longer be stored. In closed files values can only be viewed.

When you create a new file and another file is already open a warning screen will ask if you want to close the last file.



Press **<** to confirm that you want to close the open file to create (open) a new one or press **>** to cancel and return to the menu.

Figure 4.4: Close file confirmation screen

4.4 Actions over single files

Memory » Files » "Hi_File"

Press **↵** on any file that is not empty and a menu will open with all options for that file.



Figure 4.5: Individual file menu options

4.4.1 *View data in a single file*

Memory » Files » "M1_File" » View Data

| | A | B | C |
|-------|-----|-----|-----|
| 1 | 765 | 761 | 765 |
| 2 | 763 | 764 | 763 |
| 3 | 764 | 764 | 765 |
| 4 | 762 | 765 | 764 |
| 5 | 764 | 766 | --- |
| 6 | 763 | 767 | --- |
| A: 1: | 765 | HL | |

Press  on **View Data** to see values stored in the file.





Press  to exit the file.

Figure 4.6: View file in grid format

To move within the grid use the cursor keys and press the  key to go to the last column that contains data.

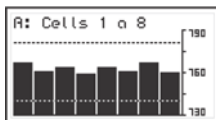

Press  on any value within a column to open a histogram representing all values within the column.

Press  to exit the histogram and return to the grid.

Figure 4.7: Histogram of a column of values

High and low hardness alarms can be seen in the histogram as horizontal dotted lines.

4.4.2 The “Q” key in a grid

Press **Q** to open the quick access menu that allows you to go directly to a position inside the grid.

Select the **Row**, **Column**, and **Cell** using the **<** **^** **>** keys.

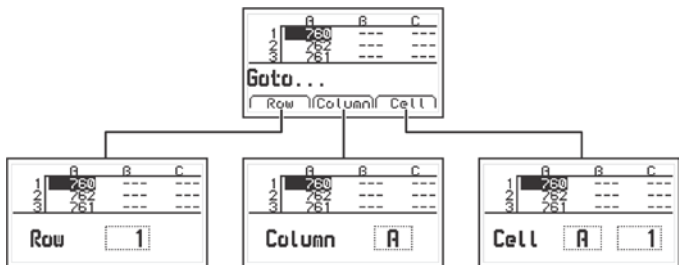



Figure 4.8: Quick access menu options in a grid

Row: Enter a row number using the cursor keys so that when you touch **↵** the grid will position itself directly on that row.

Column: Enter the column letter using the cursor keys so that when you touch **↵** the grid will position itself on that column.

Cell: This is a combination of (column and row) so that you can go to a specific cell after you enter the row number and column letter.

4.4.3 The “Q” key in a histogram

Press the  key in the histogram to open the quick access menu that allows you to obtain statistical information for the group of values being displayed.

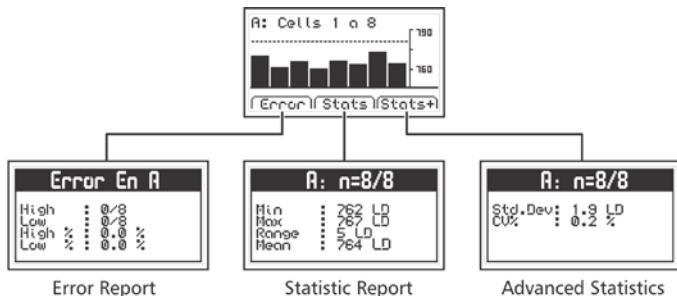

Figure 4.9: Quick access menu options in a histogram

Error: Displays the number of errors and error percentage values in the batch based on the high and low alarm settings.

Stats: View statistical information for the batch including Min., Max., Range and Mean values

Stats+: View the standard deviation and the percentage (coefficient variation) for the batch.

4.4.4 *Rename file*

Memory » Files » "Hi_File" » Rename

Press  on **Rename** to open the text editor and change the name of the file.

4.4.5 *Send data in file*

Memory » Files » "Mi_File" » Send

Press  on **Send** to values from a single file to a PC using Windows HyperTerminal. Files can also be sent to a printer using an RS232 connection. This option does not work in USB mode.

4.4.6 *View file size*

Memory » Files » "Mi_File" » Size

Press  on **Size** to view the number of values within a single file (the size of the file as a percentage of total unit memory). You can also view the date and time in which the file was created.

4.5 *Actions on all files*

Memory » For All





Press  on **For all** to open the menu for actions that will affect all files stored in the unit memory.

Figure 4.10: Actions over all files menu

4.5.1 *Send all files*

Memory » For All » Send All

Press  on **Send All** to send all files stored in the unit memory to a PC using Windows HyperTerminal. Files can also be sent to a printer using an RS232 connection. This option does not work in USB mode.

4.5.2 *Erase all files*

Memory » For ALL » Erase ALL

The **Erase All** action permanently deletes all files stored in the unit memory and recovers 100% of the memory capacity.

Before files are actually deleted a screen will be displayed asking you to confirm or to cancel this action.



Press **>** to cancel and return to the previous menu or press **<** to begin deleting all files.

Figure 4.11: Erase all confirmation screen

When the erase all action has been confirmed the following screens will be displayed:

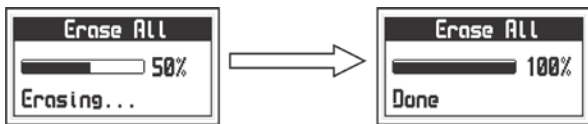

Figure 4.12: Erase all progress screen

4.6 Quick memory menu (Mem key)

Press **V** on the measuring screen to open the quick memory menu.



Figure 4.13: Quick memory menu options

In each quick memory menu screen three options are displayed. To access these options use the **<** - **^** - **>** keys. To change memory screens use the **V** key as seen on figure 4.13.

Options in the first quick access memory screen:

Label: Allows you to tag a value with a number from 0 to 65535 so that it can be easily identified in the grid that you open in DataCenter. Tags are not seen in the grids displayed in the unit.

Close: Close the current file and open a new one.

Delete: Delete the last stored value.

Options in the second quick access memory screen:

Time: Inserts the time when the value was stored.

Auto: Activates the auto capture mode.

Manu: Activates the manual capture mode.

4.7 Connecting to a PC with DataCenter

Memory » Connect

Press  on **Connect** to enter “Connect Waiting: USB” mode.

Press  to exit and cancel the connection.



Figure 4.14: Connecting to a PC

With the unit waiting to connect follow these simple steps: plug the USB cable first to the QH7 and then to the PC, open dmq DataCenter software on your PC and click <Connect> in DataCenter.

When a successful connection is established the files in your unit memory will appear in DataCenter. To view their contents simply double click on each file.

For additional information on dmq DataCenter software refer to the manual included in the dmq pendrive that you received with your QH7 or download the manual at:

<http://www.demeq.com/Download.html>



Important

Make sure that the QH7 is configured with the same interface (USB, RS232, Bluetooth) as that in DataCenter.

4.8 Datalogger configuration

Memory » Configure

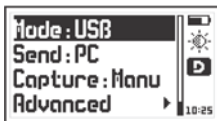

In the memory menu touch  on **Configure** to open the Datalogger configuration options menu.

Figure 4.15: Datalogger configuration menu

4.8.1 Configure communications

Memory » Configure

The first two options in the Datalogger configuration menu are **Mode** and **Send** which allow you to select how the unit will communicate with a PC and if you will be sending data to a PC or to an external printer.

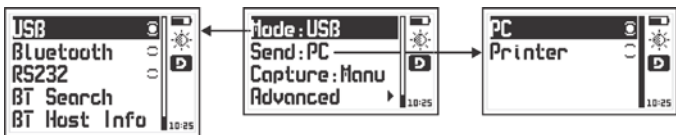



Figure 4.16: Configure communications options

Press  on **Mode** to select the type of connection.

USB: Select USB to connect to a PC using a USB cable (included).

Bluetooth: Choose to connect without cables (DataCenter Blue-32 must be installed in your PC)

RS232: Select RS232 to connect to a PC or printer using an RS232 cable (optional).

Press  on **Send** to select whether you will send files to a PC or to a printer.

PC: When using an RS232 cable the unit sends data in an optimal format for Windows HyperTerminal (38400-8-N-1).

Printer: Using an RS232 cable and printer the unit sends data in an optimal format for mini-printers of 40 columns (9600/8-N-1).

Notes

The printer option can only be used in RS232. Files cannot be directly sent to a USB printer.

When using DataCenter to selecting to send to a PC or printer will not affect communication.

4.8.2 Search for Bluetooth devices

Memory » Configure » Mode » Search BT

Before sending data via Bluetooth you need to establish a connection with the device that will receive data sent from the QH7. To being doing this bring the QH7 close to the device that you want to connect to and press  on **Search BT**.

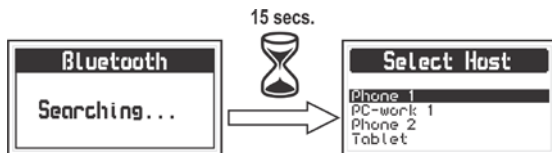

Figure 4.17: Searching for Bluetooth devices

At this point in time the QH7 will show “Searching...” and in approximately 15 seconds the unit will show all available Bluetooth devices that are close to the unit.

Use the **▲** - **▼** keys to select the device that you want to connect to and press **↵** to finish configuring Bluetooth communications.

4.8.3 *Show receiving device*

Memory » Configure Mode » Info Host BT



Press **↵** on **Info Host BT** to see the “identity” of the device that you are connecting to via Bluetooth.

Figure 4.18: Bluetooth receiving device identity

4.8.4 *Capture modes*

Memory » Configure » Capture



Press **↵** on **Capture** to select the mode in which values will be stored in the Datalogger.

Figure 4.19: Memory capture options

The QH7 has two modes in which to store values:

Manual: Press the **▲** key to store values.

Auto: Measurements are automatically stored in the Datalogger and you can also store values manually touching the **▲** key.

4.8.5 *Advanced configuration*

Memory » Configure » Advanced











Press  on **Advanced** to access the advanced configuration options menu for the Datalogger.

Figure 4.20: Advanced configuration options

When you enable **History** the Datalogger will register the unit settings for each measurement that is stored (this information can only be viewed in DataCenter). When history is enabled the unit memory capacity decreases as more data is stored.

Press  on **History** to enable or disable this option and press  to exit.

Press  on **Clock** to set the time and date options that will be recorded by the Datalogger each time a new batch is opened.

Press   to scroll menu options and  to select and exit. To exit without making changes press .

Clock menu options include:

Off: The Datalogger does not record date and time.

Date: When a new batch is opened the Datalogger records the date.

Time: When a new batch is opened the Datalogger records the time.

Both: When a new batch is opened the Datalogger records the date and time.

Tips on how to measure correctly (Leeb)

Make sure to use the best impact device for your application based on the actual material, as well as the hardness unit and actual hardness range that you want to measure. Refer to the table below.

Measuring ranges and hardness unit (Leeb)

| Unit | Impact device type | | | | | |
|----------------------|--------------------|--------------|--------------|--------------|--------------|--------------|
| | D/DC | D+15 | DL | C | G | E |
| Steel and cast steel | | | | | | |
| HB | 80~647 | 80~638 | 80~647 | 80~683 | 90~646 | 83~663 |
| HV | 80~940 | 80~937 | 80~940 | 80~996 | — | 84~1211 |
| HRA | — | — | — | — | — | 61~88 |
| HRB | 38~99 | — | 38~96 | — | 48~100 | — |
| HRC | 20~68 | 19~68 | 20~68 | 20~70 | — | 22~71 |
| HS | 32~99 | 33~99 | — | 32~100 | — | 36~103 |
| MPa | 275~ 2194 | 275~ 2180 | 275~ 2194 | 275~ 2194 | 305~ 2194 | 283~ 2195 |
| Alloy tool steel | | | | | | |
| HV | 80~898 | 80~935 | — | — | — | 82~1009 |
| HRC | 20~67 | 20~68 | — | — | — | 22~70 |
| Stainless steel | | | | | | |
| HB | 85~655 | — | — | — | — | — |
| HV | 85~802 | — | — | — | — | — |
| HRB | 46~101 | — | — | — | — | — |
| HRC | 20~62 | — | — | — | — | — |
| Grey cast iron | | | | | | |
| HB | 90~664 | — | — | — | 92~326 | — |
| HRC | 21~59 | — | — | — | — | — |
| HV | 90~698 | — | — | — | — | — |
| Spheroid iron | | | | | | |
| HB | 95~687 | — | — | — | 127~ 364 | — |

Hardness Ranges (continued)

| Unidad | Tipo de dispositivo | | | | | |
|----------------------|---------------------|------|--------|--------|--------|--------|
| | D/DC | D+15 | DL | C | G | E |
| Spheric iron (cont.) | | | | | | |
| HRC | 21~60 | — | — | — | — | — |
| HV | 96~724 | — | — | — | — | — |
| Cast aluminium | | | | | | |
| HB | 30~165 | — | 21~187 | 33~167 | 32~168 | 46~176 |
| HV | 43~193 | — | 21~191 | — | — | 47~198 |
| HRB | — | — | — | — | — | — |
| Brass | | | | | | |
| HB | 40~173 | — | — | — | — | — |
| HRB | 13~95 | — | — | — | — | — |
| Bronze | | | | | | |
| HB | 60~290 | — | — | — | — | — |
| Wrought copper | | | | | | |
| HB | 45~315 | — | — | — | — | — |

The minimum surface roughness requirements needed to obtain precise measurements are:

| | Impact device type | | | | |
|--------------------------------|--------------------|----|-----|----|----|
| | D/DC | DL | C | G | E |
| Surface condition (roughness) | | | | | |
| Roughness | N7 | N7 | N5 | N9 | N7 |
| Roughness RT (μm) | 10 | 10 | 2,5 | 30 | 10 |
| Roughness RA (μm) | 2 | 2 | 0,4 | 7 | 2 |

Don't measure test pieces that exceed the maximum hardness limits of your impact device:

| Impact device type | Maximum hardness |
|--------------------|------------------|
| D – DC – DL – E | 890 HL (68 HRC) |
| C | 960 HL (70 HRC) |
| G | 750 HL (645 HB) |

To obtain precise measurements the following minimum mass and thickness requirements must be met:

| | Impact device type | | | | | |
|---|--------------------|------|-------------|---|-----------|------------|
| | D/DC | D+15 | DL | C | G | E |
| Minimum test piece weight (kg /pounds) | | | | | | |
| Stand alone | 5 / 11 | | 1,5 / 4,9 | | 15 / 33 | 5 / 11 |
| With support | 2 / 4,4 | | 0,5 / 1,1 | | 5 / 11 | 2 / 4,4 |
| Coupled | 0,1 / 0,22 | | 0,02 / 0,04 | | 0,5 / 1,1 | 0,1 / 0,22 |
| Minimum test piece thickness (mm / inch) | | | | | | |
| Coupled | 3 / 6,6 | | 1 / 2,2 | | 10 / 22 | 3 / 6,6 |
| Superficial | 0,8 / 1,76 | | 0,2 / 0,44 | | — | 0,8 / 1,76 |

When working with a portable hardness tester you should always average at least 3 measurements at no more than 3 to 4mm from one another. The results of these measurements should do not differ in more than ± 6 HLD units. If a difference of ± 6 HLD units is obtained check test conditions and measure again.

When measuring on curved surfaces the curvature radius should not go above 0.3mm in both concave and convex angles. Always use supporting rings on non-flat surfaces.

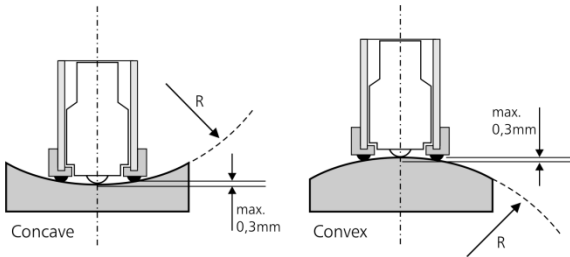

Figure A.1: Measuring on curved surfaces

Always make sure that the unit has been correctly configured for material, impact device type and impact device angle.

Don't measure over an indentation caused by a previous measurement.

Control your impact device on a reference test block at least every 500 impacts to check its condition.

The test piece surface must be clean, dry and free of grease.

Do not use lubricants or grease in the mechanical parts of your impact device.

Tips on how to measure correctly (UCI)

Choose the UCI probe that is best suited for your application and take all of the following into consideration.

Measuring ranges and hardness units (UCI)

| Unit | Material | | | |
|------|----------|----------|--------|--------|
| | Steel | Aluminum | Copper | Brass |
| HV | 100~940 | 44~189 | 40~130 | 45~196 |
| HB | 95~500 | 40~160 | 75~120 | 42~169 |
| HRB | 55~100 | 28~91 | 2~67 | 10~93 |
| HRC | 20~68 | — | — | — |
| HS | 32~97 | — | — | — |
| MPa | 320~2190 | — | — | — |

The following are minimum test piece requirements that need to be met in order to obtain precise and repetitive measurements.

| UCI probe load | 10N / 1kgf | 50N / 5kgf |
|----------------------|---------------------------------|--------------------|
| Avg. Roughness | 5 μ m | 15 μ m |
| Curvature radio | >5 mm | |
| Weight | >0,3 kg | |
| Thickness | >5 mm | |
| Indentation Depth | 250HV - 13 μ m | 250HV - 29 μ m |
| | 750HV - 8 μ m | 750HV - 17 μ m |
| Surface Layers | >10 times the indentation depth | |
| Between indentations | >3mm | |

Do not apply force on the UCI probe right after connecting the probe to the unit as this may cause the internal calibration to fail.

To obtain best results you should always take an average of at least 3 measurements.

Always make sure to configure the unit to the material being tested.

Don't measure over a previous indentation or on corroded parts.

The test piece surface must be clean, dry and free of grease.

Do not use lubricants or grease in the mechanical parts of the probe.

Technical Specifications

Leeb Method (Impact or Rebound)

| | |
|--|---|
| Impact Devices | D, DC, DL, C, G, E |
| Materials | Steel and cast steel, Alloy tool steel, Stainless steel, Grey cast iron, Spheroid iron, Cast aluminum, Brass, Bronze, Copper. |
| Impact Angles | All directions |
| Hardness Units | Leeb, Brinell, Vickers, Shore, Rockwell A, B and C. |
| Resolution (complete range) | Leeb : 1 HL Brinell : 1 HB Vickers : 1 HV Shore : 0,1 HS Rockwell : 0,1 HRA / B / C |
| Measuring Range | 150 HL to 990 HL |
| Precision | $\pm 0,5\%$ @ 800 HLD (± 4 HLD) |
| Conversions | According to ASTM A956 |

UCI (Ultrasonic Contact Impedance)

| | |
|-----------------------|--|
| UCI probes | 10N and 50N loads (Manually Loaded) |
| Base materials | Factory Calibrated for Steel. Aluminum, Copper, Brass (User Calibrated) |
| Units | Vickers, Brinell, Rockwell B / C, Shore, MPa |

| | |
|--|--|
| Resolution (complete range) | Vickers : 1 HV Brinell : 1 HB Rockwell : 0,1 HRB / C Shore : 0,1 HS MPa: 1 MPa |
| Measuring range | 100 HV to 940 HV |
| Precision | In Vickers: $\pm 5\%$ |
| Conversions | According to ASTM E 140 and DIN 50150 |

General Specifications

| | |
|-----------------------------|--|
| Real-time statistics | Maximum, Minimum, Medium, Range and Standard Deviation. |
| Alarms | High and Low. Visible and Audible. |
| Languages | English, Spanish and Portuguese. |
| Datalogger | Up to 32500 values in 8 files. Manual and Auto capture modes. Files with alphanumeric names. Date and time registry. Viewable in grids and graphics with real time statistics. |
| Connecting to a PC | USB, Bluetooth or RS232 |
| Display | Graphical color background LCD with adjustable digital contrast. |
| Battery life | 40 hours with full charge |
| Operating temp | -10°C to +50°C |
| Dimensions | 165 x 105 x 55 mm |
| Weight | 820 gr with batteries |

Additional information

To become a part of the Demeq family of users and to receive newsletters as well as promotional offers that are available only to dmq customers please register online at:

http://www.demeq.com/form_Register.html

Unit maintenance

The QH7 was developed and manufactured for years of trouble free operation and even though the unit does not require special care the following precautions should be considered:

- Avoid contact with corrosive and abrasive substances.
- Do not clean the unit with solvents.
- Do not leave the unit display exposed to direct sunlight for prolonged periods of time as this could damage the display.
- When replacing rechargeable batteries make sure you use type "AA" Nickel-Metal batteries.
- Remove impact devices and probes by pulling from the connectors at the end of the cables and not from the cables.
- Do not twist or strangle cables.
- Don't expose the unit to temperatures below -10°C / 14°F or above 50°C / 122°F.

QH7 Accessories

| dmq part no | Description |
|--------------------|---|
| QHS101 | Type D impact device with cable |
| QHS201 | Type DC impact device with cable |
| QHS301 | Type DL impact device with cable |
| QHS501 | Type C impact device with cable |
| QHS601 | Type G impact device with cable |
| QHS010 | UCI 10 N probe with cable |
| QHS050 | UCI 50 N probe with cable |
| QHP001 | HLD Leeb test block |
| QHP101 | Certified HLD test block (inquire) |
| QHP002 | HLG Leeb test block |
| QHP102 | Certified HLG test block (inquire) |
| QHA012 | Set of 12 support rings to measure concave / convex surfaces (type D, DC, C impact devices) |
| QHG005 | Coupling paste |
| QAC001 | Thermal printer USB connecting cable |
| QAI001 | Thermal printer |
| Test Blocks | Inquire on HV, HB, HRB, HRC test blocks available in steel as well as other materials |

For more information on accessories available for your QH7 please contact Demeq at infodemeq@demeq.com

Error messages

Under abnormal conditions an error message may appear on the unit screen and should be treated as informational only.

If an error message is displayed follow the instructions described below and if the problem persists please send a detailed report at: http://www.demeq.com/form_Support.html



Figure A.2: System error message

| | |
|-----------|---|
| Error 1 | Internal Error |
| Cause | Internal Error |
| Solutions | Turn off the unit and power back on. If the problem persists contact Demeq. |

| | |
|----------|---|
| Error 2 | Attempt to overwrite a value. |
| Cause | This error can happen when the unit is turned off correctly (removing batteries) and when the unit is turned back on you try to save value in the Datalogger. |
| Solution | Download the existing values in the Datalogger to a PC and erase the memory. |

If a message appears with a different number contact Demeq.

Our website: www.demeq.com

Our website is a powerful customer support tool where you will find the latest information as it relates to your QH7 including:

- Manuals and brochures
- Firmware and software updates
- New accessories

Firmware and software updates

To download firmware and software updates to your QH7 you must have dmq DataCenter installed on your PC. To download the latest version of DataCenter visit:

<http://www.demeq.com/Download.html>

Technical support

Our service department is committed to providing prompt and courteous service. Should you encounter any trouble with your QH7 please send us a message explaining the problem to:

http://www.demeq.com/form_Support.html

